

Luminex[®]

complexity simplified.

MAGPIX[®] User Manual



For *In Vitro* Diagnostic

Use
89-00002-00-617 Rev. E
08/2023
Software version: xPONENT[®] 4.3



DiaSorin Italia S.p.A.
Via Crescentino snc
13040 Saluggia (VC) –
Italy



DiaSorin Italia S.p.A.
UK Branch
Central Road
Dartford Kent DA1 5LR
UK

Technical Support

Telephone: 512-381-4397
North America Toll Free:
1-877-785-2323
International Toll Free:
+ 800-2939-4959

Email: support@luminexcorp.com
www.luminexcorp.com



Luminex Corporation
12212 Technology Blvd.
Austin, Texas 78727
U.S.A.

Document Revision History

Effective Date	Revision	Section/Chapter	Description of Change
05/2022	C	Cover Page	Updated revision and date
05/2022	C	Symbols Glossary	Updated Manufacturer symbol description Updated footnote
05/2022	C	Intended Purpose	Updated from Intended Use to Intended Purpose Added professional laboratory use statement
05/2022	C	Back Cover	Added European Union statement
05/2022	C	Performance Specification and System Components	Added warning statement regarding hardware/ software configuration
05/2022	C	Running the Assay	Added warning statement regarding hardware/ software configuration
05/2022	C	Maintaining the System	Added warning statement regarding hardware/ software configuration
07/2023	D	Cover Page	Updated revision and date Updated European Authorized Representative Added UKCA mark Added UK Authorized Representative and address
07/2023	D	Symbols Glossary	Added UKCA mark and symbol meaning Added importer symbol and symbol meaning
08/2023	E	Cover Page	Updated revision and date
08/2023	E	Performance Specifications and System Components	Added a warning statement regarding preparing, storing, and handling reagents Replaced the term 'bleach' with 'a 0.6% sodium hypochlorite solution with no additives' Added a note clarifying what constitutes an additive Updated warning statement regarding hardware/ software configuration
08/2023	E	Running the Assay	Updated warning statement regarding hardware/ software configuration

Effective Date	Revision	Section/Chapter	Description of Change
08/2023	E	Maintaining the System	Replaced the term 'bleach' with 'a 0.6% sodium hypochlorite solution with no additives' Added a note clarifying what constitutes an additive Added a note clarifying the discrepancy in language between the software and the User Manual Updated warning statement regarding hardware/software configuration
08/2023	E	Shipping and Decontaminating the System	Replaced the term 'bleach' with 'a 0.6% sodium hypochlorite solution with no additives' Added a note clarifying what constitutes an additive Added a note clarifying the discrepancy in language between the software and the User Manual
08/2023	E	Software Functionality	Replaced the term 'bleach' with 'a 0.6% sodium hypochlorite solution with no additives' Added a note clarifying what constitutes an additive Added a note clarifying the discrepancy in language between the software and the User Manual

Table of Contents

Chapter 1: System and Software Introduction	1
Instrument Overview	1
Software Overview	1
Consumables Overview	1
Luminex Technical Support	2
Symbols Glossary	2
Chapter 2: Regulatory and Safety Considerations	5
Intended Purpose	5
Safety Testing and Certifications	5
Warnings and Precautions	7
Chapter 3: Performance Specifications and System Components	10
General System Workflow	10
Environmental Conditions	10
Performance Specifications	11
System Components	12
Subsystems	16
Recommended Additional Equipment	24
Chapter 4: Installing the System	25
The MAGPIX® Overpack	25
System Diagram	26
Unpack the System Components	27
Assemble the System	27
Remove the Shipping Plug	28
Install the Sample Probe	30
Install the Drive Fluid	32
Chapter 5: Preparing the System	34
Parts of the System	34
Power on the System	35
Log into the Software	36
Adjust the Sample Probe Height	37
Calibrate the System	39
Verify the System	40
Chapter 6: Running the Assay	41
General Software Guidelines	41
Define the Protocol	41
Define the Standards and Controls	45
Define the Samples	47

Define the Batch	48
Run the Post-Batch Routine	51
Chapter 7: Analyzing the Results	52
View the Results	52
Generate Reports	53
Export the Batch Results	53
Transmit Results to the LIS	53
Reacquire Wells from a Batch	54
Replay a Batch	54
Recalculate Batch Data	55
Chapter 8: Troubleshooting	56
Generate and Send the Support Utility File	56
Calibration/Performance Verification Failures	56
Instrument Errors	59
Low Bead Count	62
Run a Self Test	65
Customer Orderable Part Numbers	66
Chapter 9: Maintaining the System.....	67
General Maintenance Precautions	67
Maintenance Commands and Routines	68
Create a New Maintenance Routine.....	69
Maintain Instrument Fluids.....	70
Maintain Instrument Hardware.....	72
Back up the System.....	82
Archive Data	83
Maintenance Log	84
Chapter 10: Storing the System.....	86
Store the System	86
Prepare the System for Use After Storage	86
Chapter 11: Shipping and Decontaminating the System	87
Decontaminate the System.....	87
Prepare the System for Shipping.....	88
Shipment Checklist.....	88
Dispose of the System.....	89
Appendix A: Software Functionality.....	90
Software Packages.....	90
Home Page.....	91
Samples Page	95
Batches Page	96
Results Page	106
Protocols Page	115
Maintenance Page.....	125

Admin Page 135

Chapter 1: System and Software Introduction

Instrument Overview

The MAGPIX® combines the fluidics subsystem, mechanical subsystem, an electronic subsystem, and an optical sub-system with magnetic microspheres and complex computer analysis to perform multiplex assays.

The MAGPIX system operates by using magnetic beads (microspheres) that are coated with a reagent specific to a particular bioassay, enabling the capture and detection of specific analytes from a sample. The sample mixture is aspirated by the sample probe and conveyed via drive fluid into the camera chamber, where the microspheres are pulled down into a monolayer by the magnet, immobilized, and imaged. Within the chamber, microspheres are exposed to a red LED and a green LED, which excite both the internal dyes that identify each bead's color signature and the reporter fluorescence from the surface of the microspheres. The red LED is responsible for classifying the microspheres. The CL1 and CL2 filters function to categorize the microspheres based on color signature and place them properly on the bead map as well as throw out any doublets that may exist. The green LED with the RP1 filter excites the reporter fluorescence, which identifies the quantity of analyte captured for each bead region. The microspheres are then flushed to the waste fluid bottle, clearing room for the next sample.

Software Overview

xPONENT® software analyzes images. The red-illuminated images classify the microspheres and the green-illuminated images determine what elements of the sample have bonded to their surfaces. xPONENT reports the results to the user.

The primary language of the user interface is English. xPONENT uses the host PC's regional settings for displayed time, date, and numeric values. If you choose to export data in U.S. regionalization format only, you can change this setting on the Admin page > CSV Options tab and Admin page > Batch Options tab. Otherwise, data will be exported per your PC's regional settings.

Consumables Overview

Luminex® xMAP® Technology requires two kinds of reagents: common laboratory reagents and reagents created only for Luminex instruments.

Luminex Technical Support

Contact Luminex Technical Support by telephone in the U.S. and Canada by calling: 1-877-785-2323

Contact outside the U.S. and Canada by calling: +1 512-381-4397

International: + 800-2939-4959

Fax: 512-219-5114









Email: support@luminexcorp.com.











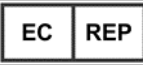

Additional information is available on the Luminex website. Search on the desired topic, navigate through menus. Also, review the website's FAQ section. Enter <http://www.luminexcorp.com> in your browser's address field.







This manual can be updated periodically. For the latest version and related translations, contact Technical Support or visit <https://www.luminexcorp.com/documents/>.

Symbols Glossary

You will encounter these symbols throughout this manual. They represent warnings, conditions, identifications, instructions, and regulatory agencies.

Symbol	Meaning	Symbol	Meaning
5.4.4* 	Caution. Indicates that caution is necessary when operating the device or control close to where the symbol is placed, or that the current situation needs operator awareness or operator action in order to avoid undesirable consequences. .	12 	Caution possibility of electric shock. To identify equipment, for example, the welding power source, that has risk of electric shock.
5.4.1* 	Biological risks. Indicates that there are potential biological risks associated with the medical device.	5041† 	Caution hot surface. To indicate that the marked item can be hot and should not be touched without taking care.
** 	Puncture/Pinch Point Warning	** 	Burn Hazard/Hot Surface
W004# 	Warning Laser Beam. To warn of a laser beam.	** 	Hand Crush/Force From Above.

Symbol	Meaning	Symbol	Meaning
5016† 	Fuse. To identify fuse boxes or their location.	5.1.4* 	Use-by date. Indicates the date after which the medical device is not to be used
5032† 	Alternating Current. To indicate on the rating plate that the equipment is suitable for alternating current only; to identify relevant terminals.	5.1.2* 	Authorized representative in the European Community/European Union. Indicates the Authorized representative in the European Community/European Union.
5.5.1* 	<i>In vitro</i> diagnostic medical device. Indicates a medical device that is intended to be used as an <i>in vitro</i> diagnostic medical device.	5.1.5* 	Batch Code. Indicates the <i>manufacturer's batch code</i> so that the batch or lot can be identified.
§ 	Conformite Europeenne (EU CE Marking of Conformity). CE conformity marking.	5.1.1* 	Manufacturer. Indicates the medical device manufacturer.
5.3.7* 	Temperature Limit. Indicates the temperature limits to which the medical device can be safely exposed.	5.1.3* 	Date of manufacture. Indicates the date when the medical device was manufactured.
5009† 	Stand-by Power on/off. To identify the switch or switch position by means of which part of the equipment is switched on in order to bring it into the standby condition, and to identify the control to shift to or to indicate the state of low power consumption. Each of different states of power consumption may be indicated using a corresponding color.	5019† 	Protective earth; protective ground. To identify any terminal which is intended for connection to an external conductor for protection against electric shock in case of a fault, or the terminal of a protective earth (ground) electrode.
5.4.3* 	Consult instructions for use or consult electronic instruction for use. Indicates the need for the user to consult the instructions for use.	5.1.6* 	Catalogue Number. Indicates the manufacturer's catalogue number so that the medical device can be identified.

Symbol	Meaning	Symbol	Meaning
5.1.7* 	Serial number. Indicates the manufacturer's serial number so that a specific medical device can be identified.	‡ 	TÜV SÜD NRTL Certification Mark. TÜV SÜD America is an OSHA-recognized Nationally Recognized Testing Laboratories (NRTL) capable of providing electrical safety certification services to North American requirements for Medical Devices, and Laboratory Test & Measurement Equipment.
§§ 	WEEE Symbol. Separate collection for electrical and electronic equipment.		MET Mark.
†† 	Ionizing Radiation. Shall be used to signify the actual or potential presence of ionizing radiation (including gamma and X-rays, alpha and beta particles, highspeed electrons, neutrons, protons and other nuclear particles, but not sound waves and other types of electromagnetic waves).	‡‡ 	UK Conformity Assessed.
5.1.8 	Importer.		

* ANSI/AAMI/ISO 15223-1:2021, Medical devices — Symbols to be used with information to be supplied by the manufacturer — Part 1: General requirements.

† IEC 60417:2002 DB, graphical symbols for use on equipment. (General I (QS/RM))

‡ ISO 7000: Fifth edition 2014-01-15, graphical symbols for use on equipment - registered symbols. (General I (QS/RM))

§ Regulation (EU) 2017/746 of the European Parliament and of the Council of 5 April 2017 on in vitro diagnostic medical devices

|| 61010-1: 2010, Safety requirements for electrical equipment for measurement, control, and laboratory use - Part 1: General requirements [including: Corrigendum 1 (2011)]

IEC 60825-1-2014 Safety of Laser Products –Part 1: Equipment classification and requirements

** ISO 3864-1:2011, Graphical symbols -- Safety colors and safety signs -- Part 1: Design principles for safety signs and safety markings

†† ISO 361: 1975 Basic ionizing radiation symbol

‡‡ Medical Devices Regulations 2002 (UK MDR 2002)

§§ DIRECTIVE 2012/19/EU OF THE EUROPEAN PARLIMENT AND OF THE COUNCIL of 4 July 2012 on waste electrical and electronic equipment (WEEE)

Chapter 2: Regulatory and Safety Considerations

Luminex recommends that all system users become familiar with the specific safety advisories and adhere to standard laboratory safety practices. Biological hazards may be present during system operation.



The system contains electrical and mechanical components that, if handled improperly, can be harmful.

Intended Purpose

The MAGPIX® system is a clinical multiplex test system intended to measure and sort multiple signals generated in an in vitro diagnostic assay from a clinical sample. This instrument system is used with a specific assay to measure multiple analytes that aid in diagnosis. The device includes a signal reader unit, raw data storage mechanisms, data acquisition software and software to process detected signals. This is an automated medical device

For laboratory professional use only.

Safety Testing and Certifications

The MAGPIX® has been tested and complies with the safety requirements for the United States and Canada and is marked with the MET label or the TUV label. Review the Symbols Glossary to determine what the labels look like.

The MAGPIX complies with the European Union (EU) safety requirements and therefore may be marketed in the Europe Single Market.

Regulatory and Safety Labels

If the following label appears on your MAGPIX® system, the label indicates that your system can be used with both xTAG® and NxTAG® assays.



The following fuse caution label appears on the back of the system.

Figure 1: Fuse Caution Label

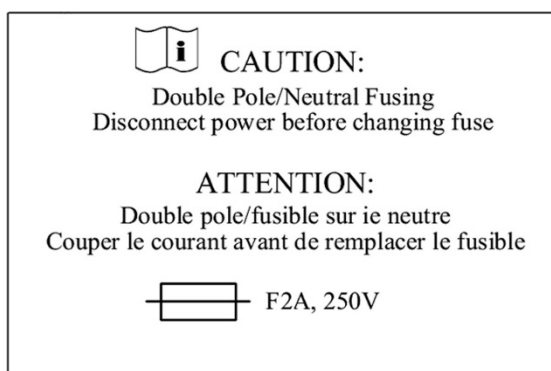

A voltage label appears on the back of the system and displays the serial number, model number, power requirements, and manufacturer's information.

Figure 2: Serial Number and Voltage Label

Luminex Corporation
12212 Technology Blvd.
Austin, Texas 78727
USA, 2016-10-20 🏭
Model: MAGPIX
SN MAGPX16294725
100-120V~, 2.0A 50/60 Hz or
200-240V~, 1.0A 50/60 Hz

Warnings and Precautions



Consult safety documentation where the caution symbol is marked.

USA Federal law restricts this device to sale by or on the order of a physician or other practitioner licensed by the law of the State in which he practices, to use or order the use of the device.

In any situation that you encounter a symbol shown below, consult this manual or other Luminex documentation to determine the nature of the potential hazard and any necessary actions you should take.

General Safety



The protection provided by the equipment can be impaired, or the warranty voided, if the system is used in a manner not specified by the Luminex documentation or by Luminex Corporation.

Keep the side access door closed and latched during normal operations. Always observe standard laboratory safety practices.

Do not, under any circumstances, remove the housing of the instrument. Use of controls or adjustments or performance of procedures other than those specified in MAGPIX® documentation can result in exposure to hazards.

Mechanical Safety



The system has parts that move during operation. Risk of personal injury is present. The moving parts present puncture and pinching hazards.



Keep hands and fingers away from the plate carrier slot, syringe pump and sample probe during operation. The plate carrier ejects without warning, especially during multi-plate batches. Observe all warnings and cautions. Keep the access door closed and latched during normal operations.

Electrical Safety



Power cords must be replaced with cords of the same type and ratings as originally provided. Contact *Luminex Technical Support* for correct replacement power cords.

Do not perform any maintenance or clean the electrical components in the system, with the exception of replacing fuses.

Observe the fuse caution stated on the fuse caution label. Be aware of the instrument voltage.

Electromagnetic Compatibility

The MAGPIX® complies with the emission and immunity requirements described in IEC 61326-1 and IEC 61326-

2-6. The electromagnetic environment should be evaluated prior to operation.



Do not use this instrument in close proximity to sources of strong electromagnetic radiation, for example, unshielded intentional RF sources, as these may interfere with the proper operation.



Always handle the instrument according to Luminex instructions to avoid any possible interference from its electromagnetic fields.

Barcode Reader Laser

The accessory barcode reader is classified under FDA 21 CFR 1040.10 and 1040.11 as a Class 2 laser product. In accordance with IEC 60825-1:2014, the accessory barcode reader is classified as Class 2.

The barcode reader laser presents a potential hazard to eyesight.



Do not stare into the barcode reader beam or shine it into other people's eyes.

Heat Safety

The heater plate, used to warm the plate carrier of the Y platform, can be heated between 35°C and 60°C.



Do not use the heater plate as an incubator. Its purpose is to maintain the temperature of the plate while the plate is in the MAGPIX® instrument. Monitor the heater plate temperature while it is in use. If it overheats, discontinue use and contact *Luminex Technical Support*.



The heater plate of the MAGPIX® plate carrier may be hot and can cause personal injury if touched. Do not touch the heater plate.

Fluids Safety

This system contains fluids. In the event of a fluid leak, turn off all power to the system and disconnect all power cords. The on/off switch is not a method of disconnection; the power cord must be removed from the outlet. Contact *Luminex Technical Support* for further information.

Monitor waste fluid levels periodically as a precaution. Do not allow the waste fluid bottle to overflow. Empty the waste fluid bottle each time you replace the drive fluid bottle.





Do not operate the instrument in the presence of leaking fluid.

If biological samples have been tested with the system, use your standard laboratory safety practices when handling system waste.

Biohazard/Biological Safety

Human and animal samples may contain biohazardous infectious agents.

Follow the IVD assay manufacturer's instructions for use on the preparation of biological samples prior to loading onto the instrument, as concentrated biological samples can result in system clogs.

	<p>Where exposure to potentially biohazardous material, including aerosol, exists, follow appropriate biosafety procedures and use personal protective equipment (PPE). PPE includes gloves, gowns, laboratory coats, face shields or mask and eye protection, respirators, and ventilation devices.</p> <p>Observe all local, state, federal and country-specific biohazard handling regulations when disposing of biohazardous waste material.</p> <p>Samples and waste fluid can contain biohazardous infectious agents. Handle them at Biosafety level 2, as recommended for any potentially infectious human serum or blood specimen in the DCE/NIH manual, Biosafety in Microbiological and Biomedical Laboratories, 1984.</p>
	<p>Although microspheres do not contain hazardous or carcinogenic components at toxic levels, they can be toxic if swallowed. In addition, contact with acids liberates toxic gases. If microspheres come into contact with skin, wash immediately with copious amounts of water. In case of an accident, seek medical advice immediately and show the product label or bottle to your medical provider. A safety data sheet (SDS) is available upon request.</p>

NOTE: Do not use strong organic solvents with the system. Contact *Luminex Technical Support* when in doubt about compatibility of cleaning and decontamination agents or materials.

Indicator Light

The indicator light inside the front panel of the MAGPIX® indicates the status of the system and are harmless. The blue light-emitting diodes (LEDs) do not emit light in the UV spectrum.

Chapter 3: Performance Specifications and System Components

General System Workflow

The mechanical system. A user places a plate on the plate carrier, which transports the plate into the instrument. The plate carrier moves along the y-axis, to allow the sample probe access to each well column of the plate. The sample probe assembly moves along the x and z axes, allowing the sample probe to access each well of the plate. Between the y-axis movement to the plate carrier and the x-axis movement of the sample probe, all wells of the plate are accessible.

The fluidics system. The sample probe descends into each well of the plate, acquires a sample for testing and acquires drive fluid from the drive fluid bottle. The sample moves through the fluid tubing to the optics system, transported by the drive fluid.

The optics system. A magnet holds the magnetic microspheres in place while first a red (classification) LED and then a green (reporter) LED illuminate the microspheres. The microspheres are imaged during illumination. After the images are recorded, the magnet withdraws, releasing the microspheres for transport to the waste fluid bottle and to clear the path for the next sample.

Environmental Conditions

- Indoor and professional use only
- Operating temperature: 15°C to 35°C (59°F to 95°F)
- Shipping and Operating relative humidity: 20% to 80%, non-condensing
- Operating altitude: up to 2400 m (7874 ft) above mean sea level
- Shipping temperature: 0°C to 50°C (32°F to 122°F)
- Storage temperature: 10°C to 40°C (50°F to 104°F)

Performance Specifications

General System Specifications

- Start-up time: Under 15 minutes, including flushing system lines, system calibration, and system verification
- System verification: 5 minutes
- Shutdown time: Under 15 minutes
- Time to complete one 96-well plate: Under 1 hour with 50 regions, 2000 microspheres per region per well, counting 50 microspheres in each region, aspirating 30 μ L out of a 75 μ L sample
- Physical dimensions: 20.3 cm (8 in) width, 66 cm (26 in) depth, 43.2 cm (17 in) height
- Weight: 18.0 kg (40 lbs)
- Installation Category II
- Pollution degree 2
- Temperature control: maintains samples using the heater block at a constant temperature from 35°C to 60°C (95°F to 131°F) +/- 1°C of setpoint.
- Automatic transfer of assay protocols and new reagent information into the system using a large capacity read/write DVD
- Automatic sampling from a 96-well plate, beginning from any well position
- Automatic real-time analysis
- Analysis of multiple assay protocols per plate
- Barcode reader entry of sample IDs
- Produces sound pressure levels below 85 dBA

Electronics Specifications

- USB 2.0-compatible communications link for fast data transfer
- Input voltage range: either 100 V~ to 120 V~, 2.0 A, 50 Hz to 60 Hz or 200 V~ to 240 V~, 1.0 A, 50 Hz to 60 Hz

Optics Specifications

- Reporter channel detection: A/D resolution 12 bits
- Reporter detector: xMAP® imager, detection bandwidth of 566 to 614 nm
- Classification detector: xMAP imager
- Limit of Detection (LOD): For the reporter channel, using a blank microsphere from region 078, \leq 700 molecules of phycoerythrin (PE) per microsphere
- Reporter Channel Dynamic Range: use a microsphere from region 078, \geq 3.0 decades
- Efficiency: Classification Channels: \geq 80%

Fluidics Specifications

- Sample load rate: 20 mL to 500 mL per second
- Sample uptake volume: 20 µL to 200 µL
- Well-to-well carryover: ≤ 4%
- Sample uptake accuracy: +/- 5%

Microspheres Specifications

- Distinguishes 1 to 50 unique MagPlex® microspheres in a single sample
- Misclassification Rate ≤ 2%
- Classification Rate ≥ 80%
- Detects and distinguishes surface reporter fluorescence emissions at 590 nm +/- 24 nm on the surface of 1 to 50 unique MagPlex microsphere in a single sample
- Soluble background fluorescence emission at 590 nm +/- 24 nm automatically subtracted from fluorescence intensity values
- Internal sample carryover: < 1.5%
- Detects a minimum of 500 fluorochromes of Phycoerythrin (PE) per microsphere

Plates Specifications

- Plate must be 96-well, not to exceed 2.54 cm (1 in) in height, including heater block.
- Plate must be compatible with the heater block temperature when the heater block is in use.
- All plates have standard width (85.5 mm) and length (127.9 mm).
- Depth varies depending on the type of well. Maximum allowable depth is 2.54 cm (1 in).
- Plates must have minimum 1.5 mm (0.06 in) lip height, standard distance from well center to well center (9 mm (0.35 in)) and standard distance from A1 center to plate center in both length and width.
- To be compatible in size with the heater block, the plate must fit into the heater block so that the top is flush with the heater block.

System Components

The three components of the MAGPIX® System are: software, hardware, and reagents.

Software Component

xPONENT® software provides complete control of the system and performs the analysis. The software requires a dedicated PC. For updated information about the PC or operating system, refer to the software release notes, or access <http://www.luminexcorp.com>.

Under most circumstances, the PC that comes with the MAGPIX® system is preloaded with xPONENT for MAGPIX software. Luminex provides software on media to use if you need to reinstall the software or need to install it on another computer.

The software media automatically installs the 21 CFR and Security modules on a temporary license. The 21 CFR and Security modules are only active for 90 days. If you do not purchase a permanent license key for 21 CFR and Security modules, then you will not need a user ID and password to access the basic functions of the software. Contact *Luminex Technical Support* if you choose to purchase the 21 CFR and Security Modules.



If you need to uninstall, reinstall, or install additional instances of xPONENT®, please contact Luminex Technical Support. Versions of xPONENT are only compatible with specific xMAP® instruments. Use of an incompatible version of xPONENT is not a supported configuration and may lead to calibration or performance verification failure. Before performing any software uninstall or installation steps, contact Luminex Technical Support to ensure that hardware and software versions are fully compatible and supported.

The software is documented in online help, which can be accessed from within the application itself, in PDF form, which is available on the Luminex website, and on media included with the shipped system.



Luminex recommends that you do not install additional software on the PC that runs xPONENT, with the exception of Adobe Acrobat. Acrobat is required to view the PDFs and is included on the installation DVD. The operation of xPONENT for MAGPIX has been validated only when it is the only program running on the dedicated PC.

Hardware Components



The MAGPIX® system includes the following hardware:

- The MAGPIX instrument
- Personal computer (PC) and necessary peripherals, including a monitor, keyboard, and mouse
- Power cable to connect MAGPIX to power outlet
- USB communication cable to connect MAGPIX to PC
- Two sample probes
- Sample probe height adjustment kit
- Off-plate reagent block
- Additional empty waste fluid bottle
- Side door access tool
- Barcode reader (optional)
- Heater block (optional)

The hardware is shipped with a quick installation guide, a quick software user guide, the software and hardware user manual, and the software.

Consumable Components

xMAP® Technology Reagents

	Protect MAGPIX® calibration and verification reagents from light at all times to avoid photobleaching of the microspheres.
	MAGPIX Drive Fluid and the solution in which microspheres are stored contain ProClin®, which may cause an allergic reaction. Use personal protective equipment (PPE), including gloves and safety glasses. Check the assay package insert for assay component information. Additional information is available in the drive fluid SDS.
	MAGPIX Drive Fluid PLUS contains, and other laboratory reagents can contain, sodium azide as a preservative. Sodium azide may react with lead and copper plumbing to form highly explosive metal azides. Refer to local guidelines and regulations for proper disposal of unused and used MAGPIX Drive Fluid PLUS, as well as other laboratory reagents containing this preservative.
	Adhere to standard laboratory safety practices when handling hazardous, toxic, or flammable reagents and chemicals. Contact <i>Luminex Technical Support</i> when in doubt about compatibility of cleaning and decontamination agents or materials.
	Only use reagents, assays, or other consumables that are within their expiration date. Dispose of all expired reagents, assays, or consumables in the appropriate waste fluid container.

- MAGPIX Drive Fluid or MAGPIX Drive Fluid PLUS (unit volume sufficient to run eight 96-well plates)
- MAGPIX Calibration Kit (to normalize the CL1 and CL2 classification channels and the RP1 reporter channel parameters)
- MAGPIX Performance Verification Kit (to verify system integrity associated with the CL1 and CL2 classification channels, the RP1 reporter channel, and the system fluidics).

MAGPIX is shipped with a 2-pack of drive fluid. A MAGPIX Calibration Kit and a MAGPIX Performance Verification Kit are shipped separately.

Required Laboratory Reagents

	Isopropanol and ethanol are flammable liquids. Keep them away from heat, open flames, and sparks in a well-ventilated area. Remove them from the instrument when they are not in use.
	Formulated reagents must be free of particulates other than xMAP® microspheres. Do not dilute xMAP calibrators or verifiers.

NOTE: Refer to the manufacturer's documentation and your site's operating procedures when preparing, storing, and handling reagents.

- 0.6% sodium hypochlorite solution with no additives

NOTE: Sodium hypochlorite solutions containing small amounts of sodium chloride (NaCl), sodium carbonate (Na₂CO₃), sodium hydroxide (NaOH), and other pH buffers may be used. Do not use sodium hypochlorite solutions containing film-forming agents, such as Dialyldimethylammonium Chloride

(DADMAC), or other additives.

- 70% isopropanol or 70% ethanol solution
- Sodium hydroxide (0.1N NaOH)
- Sporidicin® Disinfectant
- Mild detergent
- Distilled water

Subsystems

Mechanical Subsystem

x-Axis and y-Axis Movement

The mechanical subsystem includes the plate carrier and the assembly that moves the sample probe. The carrier moves along the y-axis, to allow the sample probe access to each row of the plate. The sample probe assembly moves along the x and z axes, allowing it to access each column of the plate. Between the y-axis movement of the carrier and the x-axis and z-axis movement of the sample probe, all wells of the plate are accessible.

Figure 3: Plate Carrier Assembly

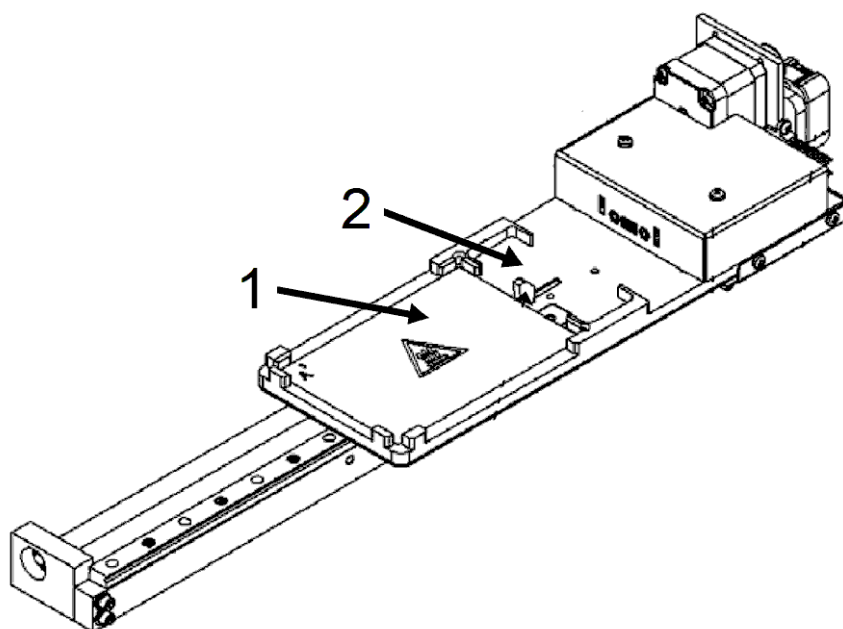

- | | |
|----|------------------------------|
| 1. | Plate area |
| 2. | Off-plate reagent block area |

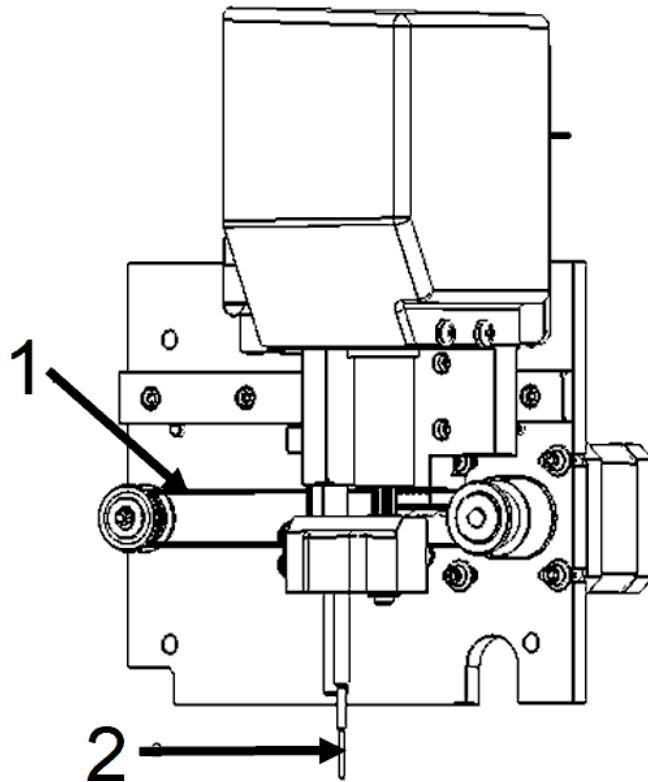
Figure 4: Sample Probe Assembly

- | | |
|----|--|
| 1. | Pulley wheel that moves sample probe assembly along x-axis (cover removed) |
| 2. | Sample probe |

Air Filters

The MAGPIX® has two air filters, one on the bottom of the instrument and one on the back of the instrument. These filters require periodic cleaning to perform optimally.

Lift or tilt the MAGPIX forward to slide the bottom filter out of its holder toward the front of the instrument. Slide the back filter up and out of its holder.



Before lifting the instrument, remove the fluid bottles, the off-plate reagent block, and the sample plate.

Electrical Subsystem

The electrical subsystem provides the power for operation and control of the MAGPIX® system and communication between its parts.

Power Input Module

The power input module contains the input power plug, hard power toggle switch, and fuses. The power input module is the protective earthing point for the MAGPIX® system. The mating power cord connector type is IEC-320-C13. The mating power cord provides electrical power to the instrument when it is connected to an electrical outlet and is the means of disconnection. The power input automatically senses the voltage range.

Figure 5: Power Input Module

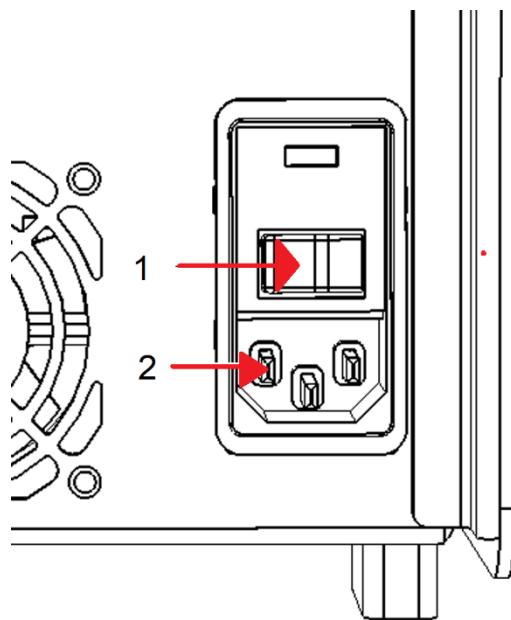

- | | |
|----|--------------------------|
| 1. | Hard power toggle switch |
| 2. | Input power plug |



Do not obstruct this means of disconnection. Connect only to outlets that contain protective earthing. Before changing a fuse, turn off the instrument and unplug the power cord to avoid any danger of electrical shock.

Communications Port

The communications port connects the MAGPIX® to the computer. It is a USB port, labeled P1.

Figure 6: Communications Port



Fluidics Subsystem

The fluidics subsystem handles the flow of liquid through the MAGPIX®. The MAGPIX has two doors that access its fluidics system: a side access door and a front door to the fluid compartment.

Side Compartment and its Components

The side compartment of the MAGPIX® contains the majority of user-maintainable components.

The side access door, at the upper front of the right side, provides access to the side compartment, which provides access to the majority of user-maintainable components: the sample probe assembly, the sample valve, the tube between the probe and the sample valve, the filter for the drive fluid, and the syringe pump. The side access door to this compartment must remain latched during operation of the instrument. Opening the side access door requires a special tool provided with the MAGPIX system.



Keep the side access door closed and latched during normal operation. Unlatch it only to perform maintenance on the user maintainable parts of the fluidics system.

Figure 7: Side Access Door

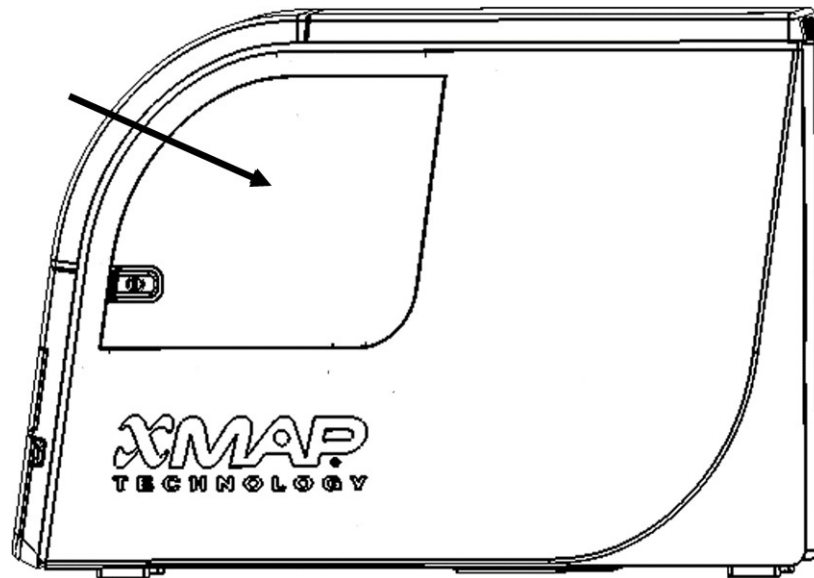
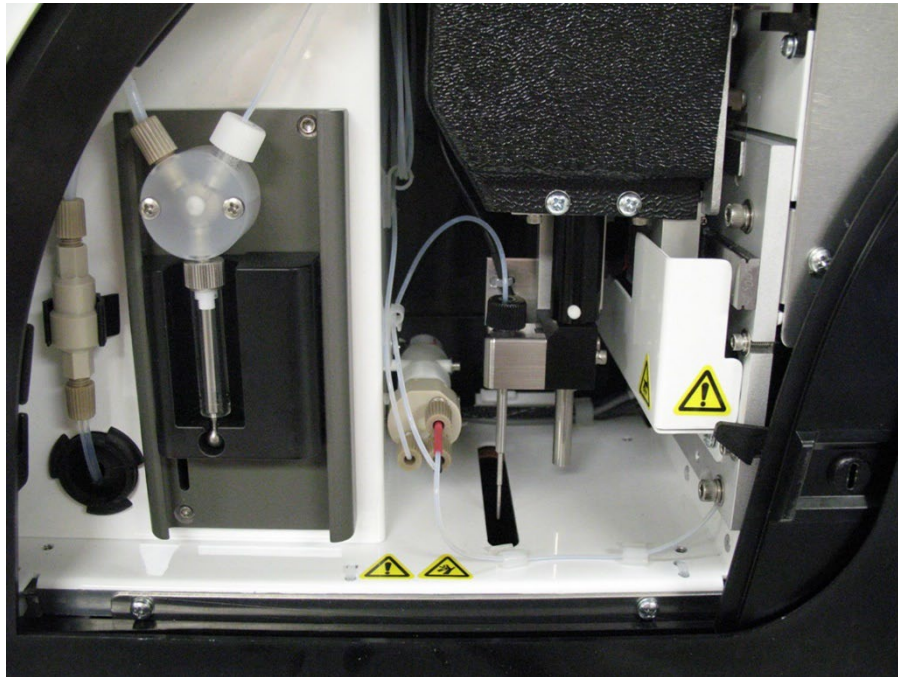

Figure 8: Interior of Side Access Door

Fluid Compartment

At the bottom of the front panel of the MAGPIX®, a door folds down to provide access to the fluid compartment. Within that compartment, two trays hold the drive fluid and waste fluid bottles. Internal sensors monitor the fullness of the waste fluid bottle and the emptiness of the drive fluid bottle. When either container reaches an unacceptable level, the MAGPIX stops. Set up an alert to warn you about unacceptable fluid levels.

Figure 9: Door to Fluid Compartment

The drive fluid bottle comes pre-filled and is disposable. The reusable waste fluid bottle receives waste from the system. The waste and drive fluid tubes connect to the waste fluid and drive fluid bottles using clear tubing.



Wear appropriate personal protective equipment (PPE) when handling parts that come into contact with potentially biohazardous samples. Make certain the waste fluid container is properly vented.

Figure 10: Fluid Compartment, Interior

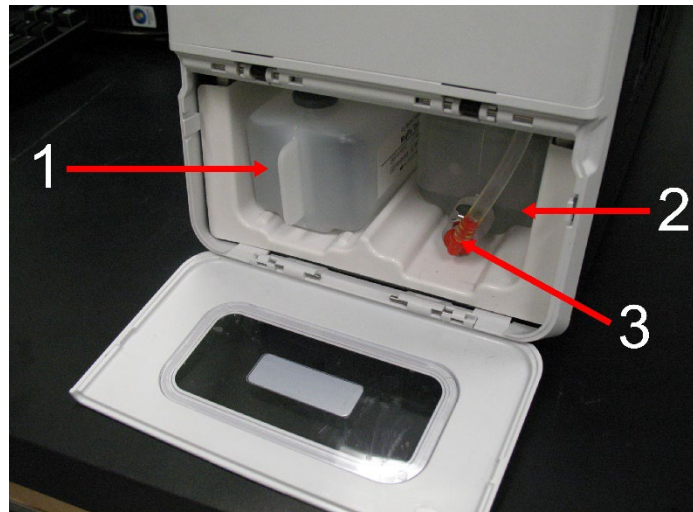

- | | |
|----|--|
| 1. | Drive Fluid bottle in place |
| 2. | Waste fluid bottle in place |
| 3. | Valve attaching waste tubing to waste fluid bottle |

Sample Probe Assembly

The stainless steel sample probe fits inside a holder. A probe fitting screws into the top of the holder, keeping the probe in place. From the probe, through the fitting, extends a tube that passes through a strain relief and attaches to the sample valve. The sample loop from the syringe pump also enters the sample valve, and a tube extends from it into the optical chamber, carrying the sample mixed with drive fluid.

A wheel pulley, covered by a protective shield, moves the sample probe assembly along the x-axis.

Figure 11: Sample Probe Assembly

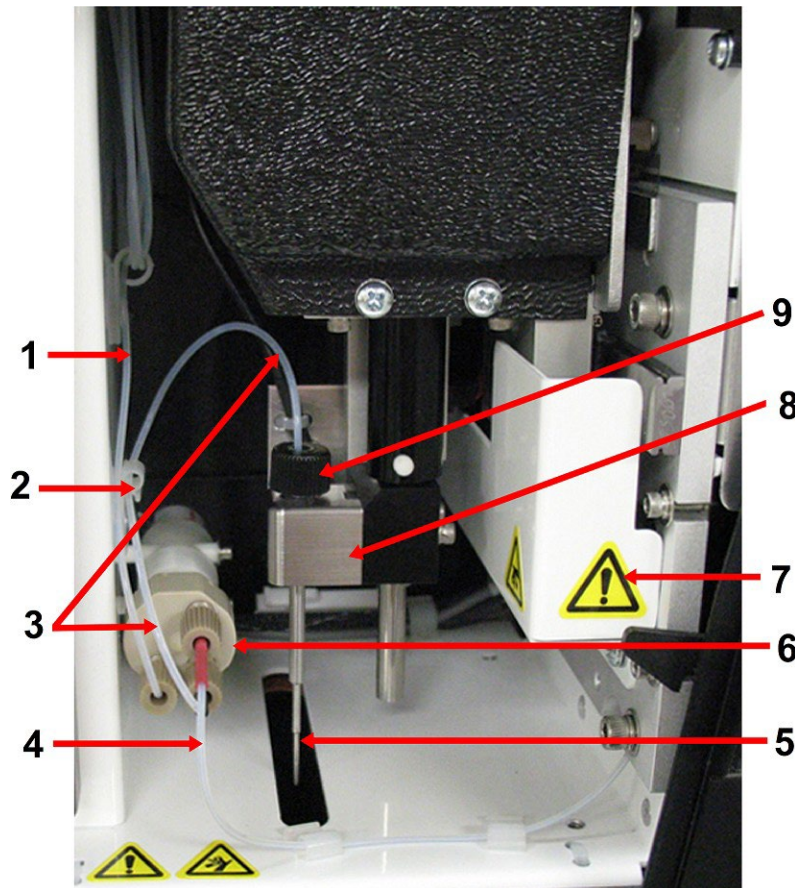

1.	Sample loop	6.	Sample valve
2.	Strain relief	7.	Protective cover on wheel pulley
3.	Probe-to-valve tube (coded black)	8.	Probe holder
4.	Valve-to-optical chamber tube (coded red)	9.	Probe fitting
5.	Sample probe		



Avoid contact with moving parts.



Wear appropriate personal protective equipment (PPE) when handling parts that come into contact with potentially biohazardous samples.

Syringe Pump and Drive Fluid Filter

The syringe pump draws fluid from the drive fluid bottle, in the bottom compartment of the instrument. The fluid first passes through the drive fluid filter, which removes particles greater than 35 microns in diameter.

The pumping action results from the up-and-down movement of the plunger guide in its mounting bracket, which moves the plunger up and down in the glass cylinder, drawing drive fluid in through the filter and into the valve and forcing it out into the sample loop.

Figure 12: Syringe Pump and Drive Fluid Filter

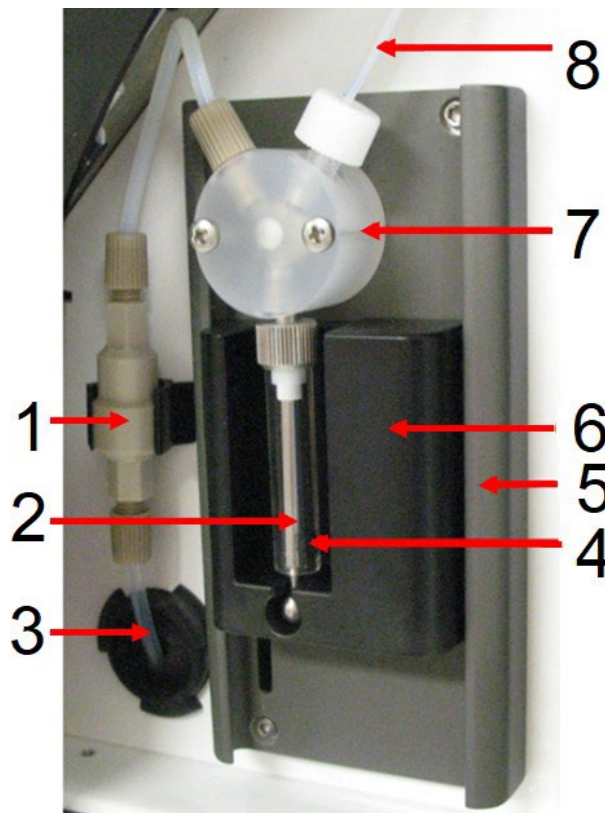

1.	Drive Fluid filter	5.	Mounting bracket
2.	Plunger	7.	Plunger guide
3.	Tube from Drive Fluid bottle	8.	Syringe pump valve
4.	Glass cylinder	9.	Sample loop



Avoid contact with moving parts.

Optical Subsystem

The optical subsystem consists of red and green LED illumination, an xMAP® imager, an imaging chamber, and a magnet to hold the magnetic microspheres in place during the imaging process. The optical subsystem is contained in the same area as the PCBAs. The optical subsystem is not accessible by the user and requires no user maintenance.

PC Specifications

For updated information regarding the PC operating system, go to: www.luminexcorp.com.

Recommended Additional Equipment

Successful operation of the system may require additional equipment.

Uninterruptible Power Supply (UPS) or Surge Protector - Luminex recommends using either an uninterruptible power supply (UPS) or a surge protector to protect your system from power outages. Use a UPS that provides 585 Watts/960 VA for at least 60 minutes. Choose a surge protector that fits the requirements for electrical environment, endurance, suppressed voltage rating, and method of protection. The surge protector requires three outlets and a minimum rating of 585 Watts. Both pieces of equipment should include appropriate safety certification marks for your region, for example, Underwriters Laboratory (UL) or a similar listing body, certified by Canadian Standards Association (CSA), or Conformité Européenne (CE) for non-domestic use.

Printer - Use a printer compatible with the version of Microsoft® Windows® running your PC with xPONENT®. Refer to the xPONENT release notes for the specific version of Windows.

Barcode Labels - Use Code 128 barcode label type when scanning barcode labels into the system.

Vortex - Use VWR product number 58816-12, with a speed range of 0 to 3200 rpm, or equivalent.

Bath Sonicator - Use Cole-Parmer® product number 08849-00, with an operating frequency of 55 kHz, or equivalent.

Chapter 4: Installing the System

The MAGPIX® Overpack

The MAGPIX® overpack contains the following items:

Item	Quantity	Part Number
MAGPIX® Instrument	1	
PC	1	
Monitor	1	
MAGPIX® Drive Fluid PLUS 2 Pack	1	40-50022
Waste Bottle	1	CN-0261-01
Sample Probe	2	CN-0221-01
Power Cord	1	CN-P0XX-01
USB Cable	1	CN-0271-01
Side Access Door Tool	1	CN-0264-01
Sample Probe Height Adjustment Kit	1	CN-0263-01
MAGPIX® Off-plate Reagent Block	1	CN-0260-01
xPONENT® 4.3 Software for MAGPIX®	1	CN-SW65-01
Manual, MAGPIX User (IVD)	1	CN-M087-01
PC Connection Instructions	1	89-00002-00-611
Terms and Conditions	1	89-30000-00-739
96-well plate Heater Block (optional)	1	CN-0224-01
Barcode reader (optional)	1	CN-PC03-01

NOTE: A MAGPIX Calibration Kit and a MAGPIX Performance Verification Kit are shipped separately.

Unpack the System Components

Before unpacking the MAGPIX®, ensure that where you plan to install the system complies with the environmental conditions and meets the site installation requirements.



The overpack is too heavy to be lifted by one person (approximately 53.97 kg [119 lbs], a three-person lift) and should be moved mechanically. Be careful the overpack is not punctured during any necessary moving.

The MAGPIX arrives in a large, corrugated cardboard overpack on skids. The overpack contains separate boxes for the PC, the monitor, the 2-pack of drive fluid, and the MAGPIX instrument. In addition, a divided tray contains the cables, CDs, and printed material. Each individual box can be handled by one person. The MAGPIX box and the PC each weigh less than 18.14 kg (40 lbs).

1. Remove the three boxes from the overpack that contain the PC and all of its components.
2. Remove the MAGPIX box from the overpack. The MAGPIX instrument is inside a plastic bag and surrounded by foam inserts attached to a corrugated cardboard insert.
 - a. Pull the handles that extend from the cardboard insert.

NOTE: Luminex recommends to have another person hold down the box while you pull the MAGPIX out.
 - b. Place the MAGPIX box on a flat, stable surface, using two people.
 - c. Fold down the cardboard panels from each side of the instrument.
 - d. Pull the plastic bag down from the top of the MAGPIX.
 - e. Place the MAGPIX onto a lab bench or other flat, stable surface, using two people.

Before proceeding with the installation, check the contents of the overpack with the Shipping Checklist and make certain you can locate all listed items. Check contents to make certain no damage has occurred during shipping. If anything is missing or damaged, contact *Luminex Technical Support*.

Assemble the System

The computer and monitor boxes include all the necessary cords and peripheral devices as well as complete installation instructions.

1. Assemble the PC and its components using the instructions provided by the PC vendor.
2. Locate the cords in the accessory tray of the overpack.
 - a. Plug the power cord into the back of the MAGPIX®.
 - b. Connect the USB cable to the USB card on the back of the PC and to the connector labeled P1 on the back of the instrument.

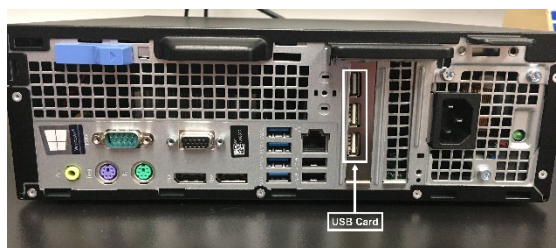

- c. Connect the barcode scanner (if ordered) to the PC and to a USB port on either the front or back.

Remove the Shipping Plug

Inside the side access door of the MAGPIX®, a shipping plug holds the sample probe assembly in place. Use the door access tool included in the accessory tray to open the side access door and remove the plug.



MAGPIX® should not be plugged into a power source when you open this compartment.

To open the side access door and remove the shipping plug:

1. Locate the door access tool in a small plastic bag in the accessory tray of the overpack.



2. Insert the tool in the side access door latch and turn it one quarter turn clockwise. Slide the door to the right.

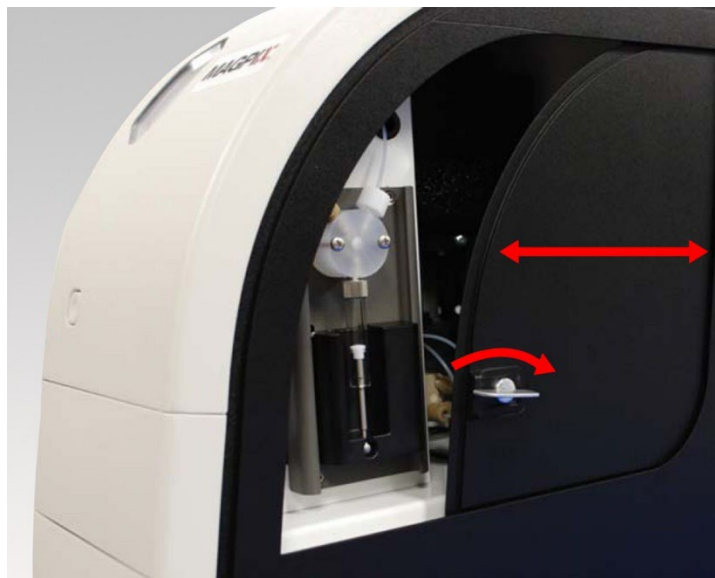

3. Raise the sample probe assembly and locate the shipping plug.

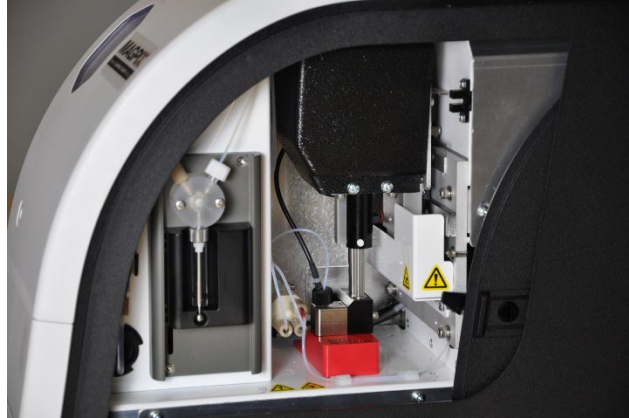

4. Pull the sample probe holder up, then, holding the MAGPIX on the top with one hand to stabilize it, firmly push the sample probe assembly away from you with your other hand. Be prepared to use some strength.

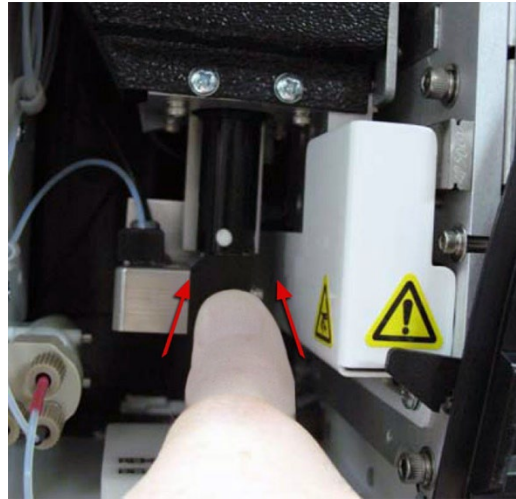

5. With the sample probe assembly out of the way, lift out the shipping plug.



Install the Sample Probe

MAGPIX® comes with two sample probes, but the sample probe is not pre-installed.

To install the sample probe:

1. Locate the sample probe, which is shipped in a tube in the accessory tray.

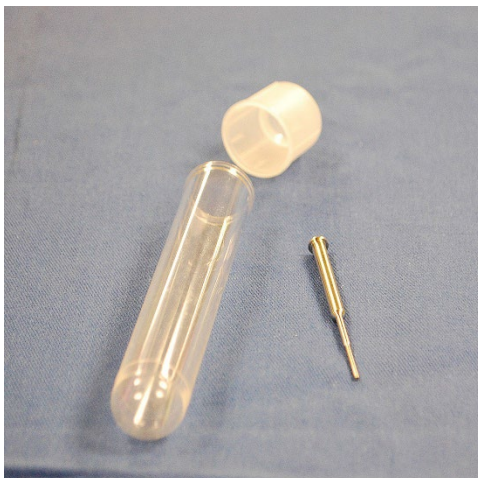

2. Pull the sample probe assembly toward you and push it down.
3. Completely unscrew the sample probe fitting on top of the sample probe holder by turning it counterclockwise.

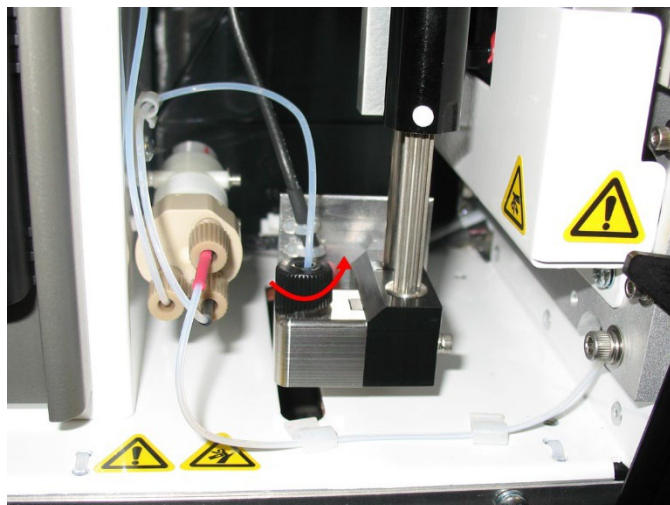

4. Place the sample probe into the opening left by the sample probe fitting. It should slip down and catch at the bottom of the opening.

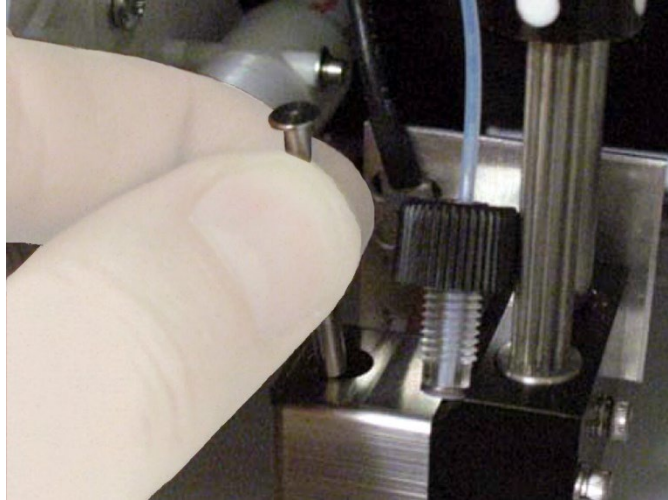

5. Reinstall the sample probe fitting, tightening it until it clicks into place.

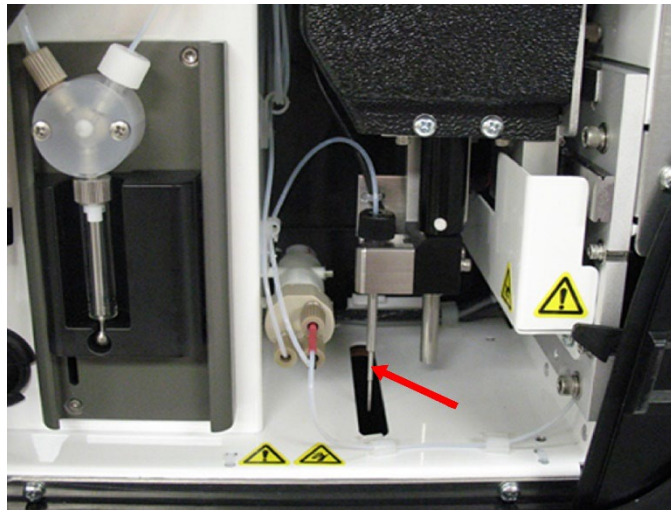

6. Close and latch the side access door.

Install the Drive Fluid

The overpack includes a box containing two bottles of drive fluid. Open the box and remove one bottle to install in the MAGPIX®.

1. Locate the box of drive fluid bottles.



2. Open the box and remove a bottle of drive fluid.
3. Open the door of the fluid compartment on the front of the MAGPIX®.
4. Pull the drive fluid tube and plug (1) in the left side of the fluid compartment forward until it extends outside the compartment. Pull it to the left to allow room to insert the drive fluid bottle.



5. Insert the drive fluid bottle part of the way into the fluid compartment opening and remove the seal.
6. Connect the drive fluid tube and plug to the opening on the top of the drive fluid bottle.



7. Slide the bottle into the tray on the left side of the fluid compartment. The tray is constructed to hold the bottle in place.

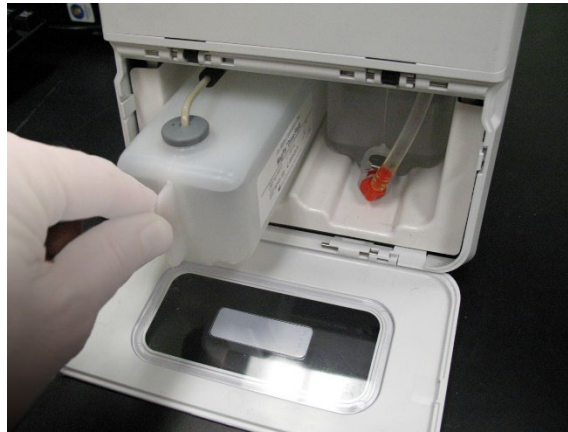

8. After the bottle is fully inserted, check the valve on the front of the waste fluid bottle to make certain it is securely attached and close the door of the fluid compartment.

Chapter 5: Preparing the System

xPONENT® for MAGPIX® contains pre-defined routines to prepare the instrument for data acquisition.

Parts of the System

Figure 13: Front and Right Side

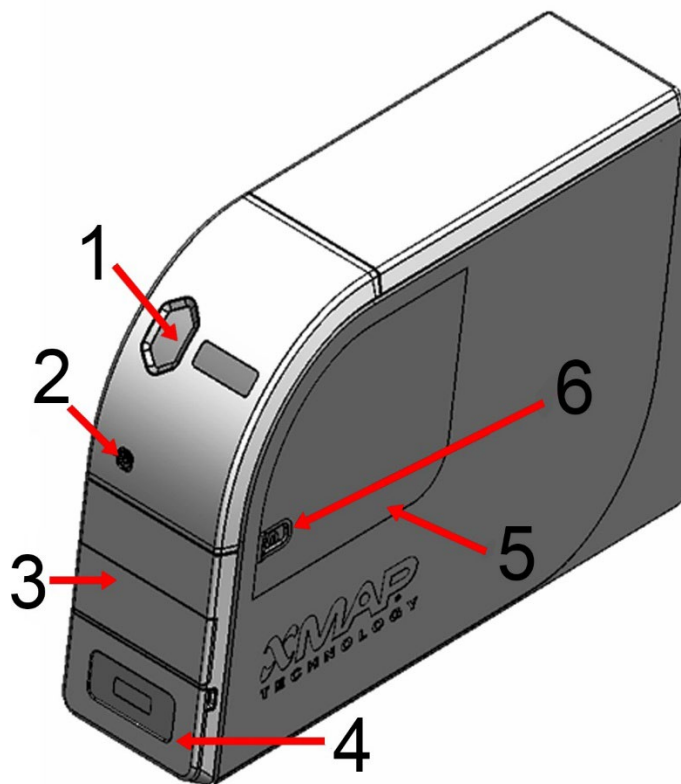

1.	Status Indicator Light	4.	Access Door for Fluid Compartment
2.	Soft On/Off Switch	5.	Side Access Door
3.	Access Door for Plate Carrier	6.	Side Access Door Latch

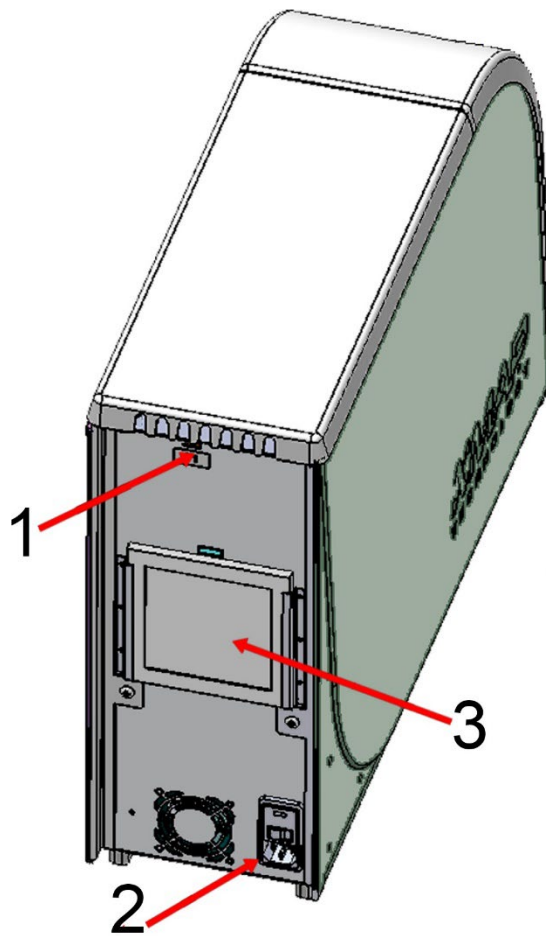
Figure 14: Back and Left Side

1.	Communications Port (P1)
2.	Power Input Module
3.	Rear Air Filter

Power on the System

MAGPIX® has two on/off switches: a hard power switch and a soft power switch. To power on the MAGPIX:

1. Turn on the PC desktop.
2. Plug the power cord from the back of the MAGPIX instrument into a power outlet.
NOTE: Luminex recommends the use of a surge protector or Uninterruptible Power Supply (UPS) device.
3. Turn on the hard power switch (1), which is located at the lower right back corner of the MAGPIX.

NOTE: The hard power switch controls flow of power to the instrument.

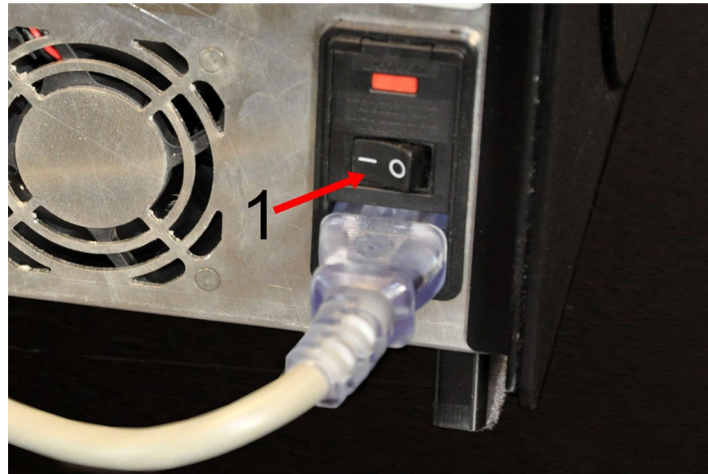

4. When you are ready to begin testing, turn on the soft power switch (2) on the front of the MAGPIX. The blue LED in the hexagonal window (3) lights up as confirmation that the power is on. The MAGPIX requires approximately 45 seconds to start up.



NOTE: The soft power switch activates and deactivates the unit.

Log into the Software

If you ordered a PC from Luminex, xPONENT® will be installed with 21 CFR and Security Modules on a temporary license. Use the default user ID and password to access the software:

User ID: admin

Password: xponent

Once an application administrator updates the user ID and password, the default user ID and password will not be active.

The 21 CFR and Security modules are only active for 90 days. If you do not purchase a permanent license key for

21 CFR and Security modules, then you will not need a user ID and password to access the basic functions of the software.

NOTE: Contact *Luminex Technical Support* if you have problems logging on. If you want to purchase a license for 21 CFR Part 11 or the security module, contact Luminex to place an order.



Use of this software by untrained personnel can result in inaccurate data and test results. Users of xPONENT must read the documentation thoroughly before operating the software.

1. On the PC desktop, double-click the Luminex xPONENT icon.
2. If this is the first time you have started the software, read the User License Agreement. Select **I accept the terms of this license agreement**, then click **OK**.
3. Enter your User ID on the **System Login** tab.
4. Enter your password if you are using a secure version of the software.
5. Click **Log In**. The **Home** page displays.

Adjust the Sample Probe Height

Adjust the sample probe height to ensure that the sample probe drops far enough in the well to acquire sample.

NOTE: Ensure that there is no liquid in the wells or reservoirs before adjusting the sample probe height.

NOTE: When you adjust and save the sample probe height settings for all three areas under a plate name, all areas retain the adjustment.



Problems with the sample probe height can lead to fluid leaks and inhibit sample acquisition.

Ensure that the sample probe height is set correctly before calibrating or verifying the system.

1. From the **Home** page, under **Daily Activities**, click **Probe and Heater**.
2. On the **Probe and Heater** tab select well D6 (this is the center of a standard 96-well plate) on the plate image. A green pin marks the selected well.
3. Based on the type of plate you are using, place alignment disks or an alignment sphere in the well.
 - for a standard 96-well plate - None
 - for a filter-bottom plate - two 5.08 mm disks
 - for Mylar-bottom plate - two 5.08 mm disks
 - for a conical (v-bottom) plate - one sphere
4. Click **Eject**.
5. Place the off-plate reagent block on the plate carrier. Make sure the plate is well seated so that it clips into place.
6. Place a strip well (provided with the Calibration and Performance Verification kit) in the off-plate reagent block.
7. In the **Strip Wells** section, select **SD1**.
8. Verify that the reservoir is empty.

9. In the **Reservoir** section, select well **RB1**.

NOTE: Verify that the plate is not warped. Warped plates can lead to incorrect probe height adjustment.

10. Place the plate on the plate carrier with well **A1** positioned as indicated on the plate carrier.
11. Click **Retract**.
12. Enter a name for the plate in the **Plate Name** field.
13. Click **Auto Adjust Height**. The sample probe automatically adjusts itself to the locations you chose.
NOTE: The sample probe height is automatically set to 0.98 mm. The sample probe automatically adjusts this distance from the bottom of the plate, or calibration disks or spheres.
14. Click **Eject**. If you used alignment disks or spheres, remove them from the plate.

Run the Revive After Storage Routine

NOTE: The Revive After Storage routine is necessary when the system runs for the first time and is recommended when the system has been idle for more than a week.

After you have adjusted the sample probe height, run the Revive After Storage (Luminex) routine.

1. Navigate to the **Maintenance** page > **Cmnds & Routines** tab.
2. From the **Routine Name** drop-down menu, choose **Revive After Storage (Luminex)**. The Revive After Storage routine performs the following commands:
 - Prime
 - Rinse
 - Alcohol Flush
 - Backflush
 - Wash
3. Click **Eject**.
4. Fill reservoir RB1 3/4 full of 70% isopropanol or 70% ethanol.
NOTE: The rinse reservoir (RD1) should be empty.
5. Click **Retract**.
6. Click **Run**.

Import Calibration or Performance Verification Kits

1. Load the CAL/VER CD (provided with the kit) on the computer.
2. From the **Home** page, click **System Initialization**.
3. Click **Import Kit** at the bottom right side of the window. The **Import Calibration or Performance Kit** dialog box opens.
4. Choose the **MPX** folder and click **Open**.
5. Choose the ***.ixl** file and click **Open**.
6. Click **OK**.

Delete Calibration or Performance Verification Kits

1. Navigate to the **Maintenance** page > **Lot Management** tab.

2. In the **Active Reagents** section, choose the kit you want to delete from the Calibration Kit or Performance Verification Kit drop-down menus.
3. Click **Delete Kit**.
4. Click **OK** in the **Delete Kit** dialog box to confirm you want to delete the kit.

Calibrate the System

Calibration is important to ensure the optical system functions effectively and different MAGPIX® systems report similar results. Calibrating the MAGPIX system normalizes the settings for the classification channels (CL1 and CL2) and the reporter channel (RP1). Use the MAGPIX Calibration Kit to calibrate the system. Following calibration, use the MAGPIX® Performance Verification Kit to check all of the optical channels in the system for correct calibration. Be sure to verify every time you calibrate. If there is a problem with optical integrity or fluidics, MAGPIX may pass calibration but fail performance verification.

If the system is not fully calibrated, a warning message displays. Track the system calibration and verification results through the Calibration and Verification report. Target value information for calibration and verification microspheres is available on the media that comes with the calibration kit and on the Luminex website at www.luminexcorp.com.

Calibrate the system at least once a week using the Calibration Verification button on the Maintenance page > Auto Maint tab. In addition, recalibrate the system if any of the following occur:

- The delta calibration temperature exceeds +/- 5°C.
- The instrument is moved.
- You experience sample acquisition problems.
- The instrument undergoes hardware maintenance, such as replacement of a part.

Calibration normalizes the settings for the system and ensures optimal and consistent microsphere classification.

1. From the **Home** page, click **System Initialization**. The **Auto Maint** tab displays.
2. Select **Calibration Verification** option under **Automated Maintenance Options**.
3. Choose the appropriate calibration kit from the drop-down menu.
4. Vortex the xMAP® calibrator and fluidics bottles at a medium speed for approximately 10 seconds to ensure homogeneity. Do not dilute the xMAP calibrator or fluidics agents.
5. Click **Eject**.
6. Fill the appropriate reservoirs 3/4 full of DI water and 3/4 full of 70% isopropanol or 70% ethanol.
NOTE: The plate layout in the software indicates reagent locations.
7. Invert the calibrator vial perpendicular to the strip well to ensure you get the necessary bead count.
8. Add 6 drops of the reagent into the designated well
9. Fill reservoir RB1 3/4 full of 70% isopropanol or 70% ethanol. The rinse reservoir (RD1) should be empty.
10. Click **Retract**.
11. Click **Run**. Once complete, click **OK**.

Verify the System

The MAGPIX® Performance Verification Kit includes reagents to verify the calibration and optical integrity for the MAGPIX system as well as reagents to verify the fluidics channels using observations of pressure, flow rate, bead count and well-to-well carryover.

Run the Performance Verification routine as part of your daily startup routine. Refer to your assay kit instructions for additional calibration frequency requirements.

Verification uses system verifiers to ensure that the instrument is functioning properly with current calibration settings.

1. From the **Home** page, click **System Initialization**. The **Auto Maint** tab displays.
2. Select the **Performance Verification** option under **Automated Maintenance Options**.
3. Choose the appropriate performance verification kit from the drop-down menu.
4. Vortex the xMAP® performance verification reagents and fluidics bottles at a medium speed for approximately 10 seconds to ensure homogeneity. Do not dilute the xMAP verification or fluidics agents.
5. Click **Eject**.
6. Add 6 drops of each reagent into the designated well.
NOTE: The plate layout in the software indicates reagent locations.
7. Fill reservoir RB1 3/4 full of 70% isopropanol or 70% ethanol. The rinse reservoir (RD1) should be empty.
8. Click **Retract**.
9. Click **Run**.

Chapter 6: Running the Assay

General Software Guidelines

	<p>Modifying or deleting xPONENT® system files can cause degradation of system performance. Repair modified or deleted xPONENT system files by uninstalling and re-installing the xPONENT software. Luminex recommends that you contact <i>Luminex Technical Support</i> before uninstalling and reinstalling xPONENT.</p>
	<p>Using unauthorized third-party software with xPONENT software can result in corruption or failure of the xPONENT software. Use third-party software at your own risk. The operation of the system software is validated only when it runs alone on the dedicated PC.</p>
	<p>If you are using a screen saver on the PC on which xPONENT is installed, xPONENT prevents it from activating. A dialog box opens each time xPONENT is launched, recommending that the screen saver and any power management settings be turned off.</p>
	<p>Versions of xPONENT® are only compatible with specific xMAP® instruments. Use of an incompatible version of xPONENT is not a supported configuration and may lead to calibration or performance verification failure. Before performing any software uninstall or installation steps, contact <i>Luminex Technical Support</i> to ensure that hardware and software versions are fully compatible and supported.</p>

Define the Protocol

NOTE: When running a kit with a provided protocol, the protocol for the assay must be run as instructed in the assay's package insert.

Edit Quantitative Analysis Settings

1. Navigate to the **Protocols** page > **Protocols** tab.
2. Choose a quantitative protocol from the **Installed Protocols** list and click **Edit**.
3. If desired, enter a new protocol name and description in the appropriate fields.
4. Enter a new version number in the **Version** field.
5. Edit the manufacturer, if needed.
6. Edit the **Acquisition Settings** and **Analysis Settings**, as necessary.
7. Click **Next** to display the **Analytes** subtab.

8. From the **Analytes** subtab, click an analyte's **Analysis** field to open the **Analysis Settings** dialog box, and edit as needed.
 - a. Choose an analysis method in the **Method** drop-down menu.
 - b. Choose a weight type in the **Weight Type** drop-down menu (Weight Type may not display, depending on the analysis method selected in the **Method** list).

NOTE: If you want an analyte to be an Intra-Well Normalization Bead, select Mark as Intra-Well Normalization Bead. The normalization bead is a microsphere set that is included in the assay as an internal control. It controls for sample variation and can be used to normalize data between samples in a run.
 - c. Click **OK** to apply the new settings to only the analyte selected, or **Apply to All Analytes** to apply the settings to all of the analytes in the protocol.
9. If you want to use a range for the analysis, click the **Analysis** field for the analyte you want to modify. The **Analysis Settings** dialog box displays.
 - a. Select **Use Threshold Ranges**, if you want to use a range for the analysis.
 - b. Click **Add Range** to setup the threshold range.
 - c. Enter a name for the range in the **Range Name** field.
 - d. Enter low and high range values in the **Low Value** and **High Value** fields.
 - e. Select the check box in the **Inclusive** columns to include the value in the range, or leave it clear to make the range value one unit higher than the low value, and one unit lower than the high value.
 - f. If you need to delete a range, highlight a range and click **Delete Range**.
 - g. Click **OK** to apply the threshold range to the analyte.
10. Click **Next**. The **Plate Layout** subtab displays.
11. Assign commands and routines to the plate layout.
12. Click **Save**.

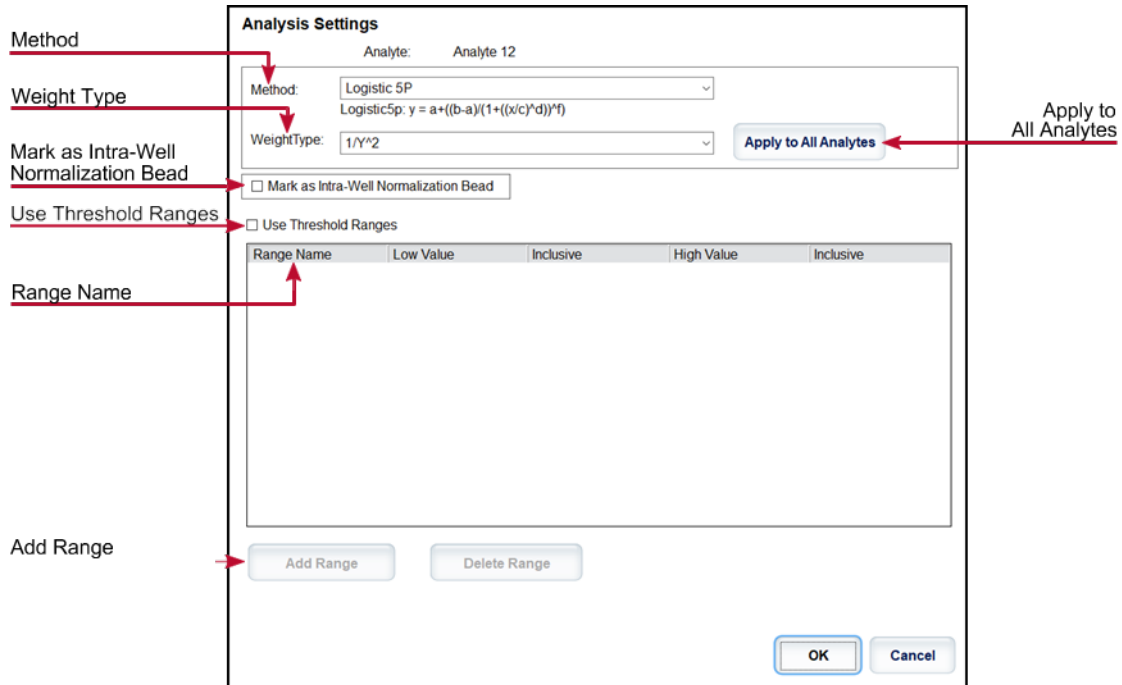

Edit Qualitative Analysis Settings

1. Navigate to the **Protocols** page > **Protocols** tab.
2. Choose a qualitative protocol from the **Installed Protocols** list and click **Edit**.
3. If desired, enter a new protocol name and description in the appropriate fields.
4. Enter a new version number in the **Version** field.
5. Edit the manufacturer, if needed.
6. Edit the **Acquisition Settings** and **Analysis Settings**, as necessary.
7. Click **Next** to display the **Analytes** subtab.
8. From the **Analytes** subtab, click an analyte's **Analysis** field to open the **Analysis Settings** dialog box.
 - a. Choose **Luminex Qualitative** or **No Analysis** from the **Method** drop-down menu.

NOTE: If you want an analyte to be an Intra-Well Normalization Bead, select Mark as Intra-Well Normalization Bead. The normalization bead is a microsphere set that is included in the assay as an internal control. It controls for sample variation and can be used to normalize data between samples in a run. Click OK or continue with the steps.
 - b. Choose **Lum Qual**, **Adv Qual**, or another saved formula, from the **Formulas** drop-down menu.
 - c. Click **New Formula** to add a new formula.
 - i. Edit the name in the **Formula Name** field.
 - ii. If you chose **Lum Qual** in the **Formulas** drop-down menu, edit the values for each range under **Negative**, **Low Positive**, and/or **High Positive**. If you chose **Adv Qual** in the **Formulas** drop-down menu, edit **Negative**, **Low Positive**, **Moderate Positive**, and/or **Strong Positive**.
 - iii. Select the check box in the **Inclusive** columns to include the value in the range. If you clear the check box, the value will be one unit higher than the low value, and one unit lower than the high value.
 - iv. Click **Add Range**, if you want to add a new range.
 - v. Enter a **Range Name**, **Low Value**, **High Value**, and select or clear the **Inclusive** check boxes.
 - d. If you want to delete a range, highlight the range, and click **Delete Range**.
 - e. Click **Save Formula**. The new formula displays in the **Formulas** drop-down menu.
 - f. Click **Apply to All Analytes** to apply the settings to all of the analytes in the protocol, or click **OK** to apply the new formula to the single analyte you selected.
9. Click **Next**. The **Plate Layout** subtab displays.
10. Assign commands and routines to the plate layout.
11. Click **Save**.

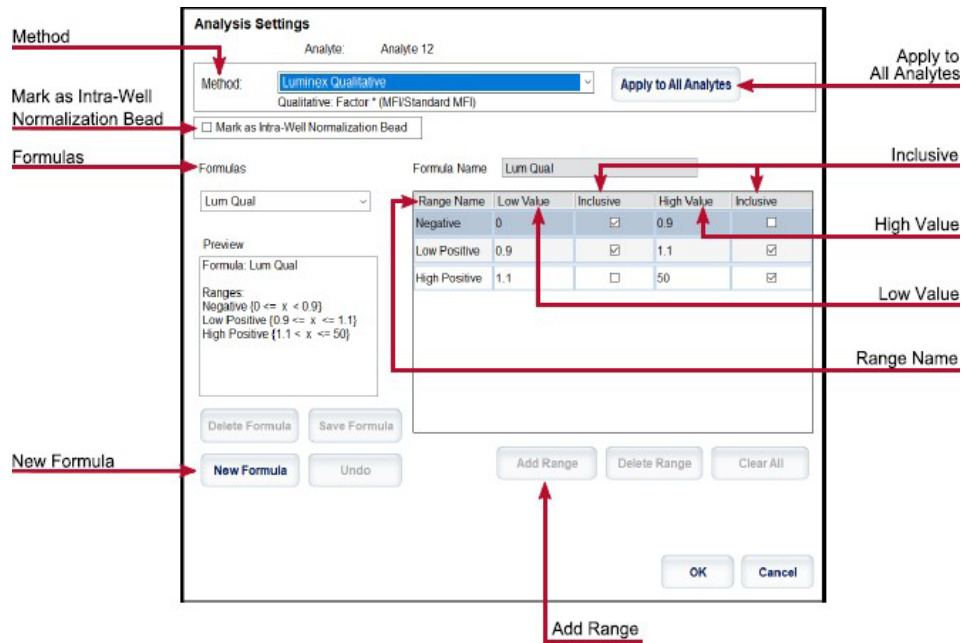

Import a Protocol

1. Navigate to the **Protocols** page > **Protocols** tab.
2. Click **Import**.
3. In the **Open** dialog box, choose a protocol file (.lxt2) to import, then click **Open**.
4. In the **Imported Protocol File** dialog box, click **OK**. The imported protocol displays in the **Installed Protocols** section.

Export a Protocol

1. Navigate to the **Protocols** page > **Protocols** tab.
2. Choose a protocol.
3. Click **Export**.
4. In the **Save As** dialog box, choose a location to export the file to, and click **Save**.
5. In the **Export File** dialog box, click **OK**.

Delete a Protocol

1. Navigate to the **Protocols** page > **Protocols** tab.
2. Choose a protocol.
3. Click **Delete**.
4. In the **Delete Protocol** dialog box, click **Yes**.

Define the Standards and Controls

Standards and Controls

Assay kits may include standards and/or controls. After you enter the assay kit information, it can be used in multiple protocols. For assay reagents specified in protocols, you can create new lots, edit lot information, select pre-existing lots for reuse, import lots, and export lots.

On the Stds & Ctrl's tab in the Installed Kits And Lots section, before deleting, exporting, importing, or editing a kit and/or lot, select the correct radio button for Std/Ctrl Kits Only or All Lots. Selecting All Lots will display all standard and control reagents and any associated Std/Ctrl Kit.

Once a lot is used, changing or modifying the lot will prompt you for a new lot or name.

Create a Standard/Control Kit

To create a standard and control kit, you must use a protocol that uses either Quantitative or Qualitative analysis settings; complete the following:

1. Navigate to the **Protocols** page > **Protocols** tab.
2. Select the protocol that you want to use for the kit, then click **New Std/Ctrl**. The **Std/Ctrl Details** subtab displays.
3. Enter the name of the kit in the **Name** field, the lot number in the **Std/Ctrl Kit Lot #** field, the expiration date using MM/DD/YY format in the **Expiration** field, and the manufacturer in the **Manufacturer** field.
4. Click **Apply Std Lot**, if you want to apply a standard lot. The **Select Lot** dialog box displays.
 - a. Choose a lot and click **OK**.
5. Click **Apply Ctrl Lot** to apply a control lot. The **Select Lot** dialog box displays.
 - a. Choose a lot and click **OK**.
6. Alternatively, enter the appropriate information in the **Assay Standard Information** and **Assay Control Information** sections. The number of standards, controls, or both in these sections is defined in the protocol. If your batch uses controls, enter values for **Expected**, **Low**, and **High** from the **Show Concentration** options. To apply the same values to multiple analytes, use the **Apply Values** arrows to apply values down or across the range of analytes.
7. Click **Save**.

Create a Standard/Control Lot

To create a standard and control lot, you must use a protocol that uses either Quantitative or Qualitative analysis settings; complete the following:

1. Navigate to the **Protocols** page > **Stds & Ctrl's** tab > click **Create New Std/Ctrl Lots**.
 - a. In the **Select Protocol** dialog box, choose the protocol you want to use for this lot, then click **OK**. The **Std/Ctrl Details** subtab displays.
 - b. Click **Apply Std Lot**, if you want to apply a standard lot. The **Select Lot** dialog box displays.
 - i. Choose a lot and click **OK**.
 - c. Click **Apply Ctrl Lot** to apply a control lot. The **Select Lot** dialog box displays.
 - i. Choose a lot and click **OK**.
2. Enter the appropriate information for each standard in the **Assay Standard Information** section.

3. In each analyte column, enter the expected concentration for the analyte. To apply the same values to multiple analytes, use the **Apply Values** arrows to apply values down or across the range of analytes.
4. To apply a dilution, choose the value or create a dilution, then click **Apply Dilution**.
NOTE: The Dilution list and Apply Dilution button only display if a quantitative analysis has been selected.
5. If your batch uses controls, enter the appropriate information for each control in the **Assay Control Information** section.
6. Enter values for **Expected**, **Low**, and **High** from the **Show Concentration** options. To apply the same values to multiple analytes, use the **Apply Values** arrows to apply values down or across the range of analytes.
7. Click **Save**.

Import a Kit/Lot

1. Navigate to the **Protocols** page > **Stds & Ctrls** tab > click **Import**.
2. In the **Open** dialog box, navigate to the location that you want to import from and click **Open**.

Edit a Kit/Lot

1. Navigate to the **Protocols** page > **Stds & Ctrls** tab.
2. In the **Installed Kits And Lots** section, choose a kit or lot and then click **Edit**.
3. If you chose a kit, edit the information as appropriate on the **Std/Ctrl Details** subtab.
NOTE: If you choose to edit a standard lot, then only the Assay Standard Information section is editable. If you choose to edit a control lot, then only the Assay Control Information is editable.
 - a. To apply the standard lot and control lot to a kit, enter the name of the kit in the **Name** field, and click **Apply Std/Ctrl Kit**.
NOTE: The chosen kit must be associated with the same analyte names.
 - b. Click **Apply Std Lot**. Select a lot from the list and click **OK**.
 - c. Apply values across or down the **Reagent**, **Name**, **Lot #**, **Expiration**, and **Analyte** fields by double-clicking the fields to enter a value, and then using one of the two **Apply Values** arrows to apply that value down or across the list of analytes.
NOTE: The Dilution list and Apply Dilution button only appear if a quantitative analysis has been selected.
 - d. Click **Apply Ctrl Lot**. Select a lot from the list and click **OK**.
 - e. Apply values across or down the **Reagent**, **Name**, **Lot #**, **Expiration**, and **Analyte** fields by double-clicking the fields to enter a value, and then use one of the two **Apply Values** arrows to apply that value down or across the list of analytes.
4. Click **Save**.

Export a Kit/Lot

NOTE: Lots and kits can only be exported if the protocol they were originally created with exists within the system. If the protocol has been deleted, the lot or kit cannot be exported.

1. Navigate to the **Protocols** page > **Stds & Ctrls** tab.
2. In the **Installed Kits And Lots** section, choose the kit or lot you want to export, then click **Export**.
3. In the **Save As** dialog box, navigate to the location you want to export the file to, then click **Save**.

Delete a Kit/Lot

1. Navigate to the **Protocols** page > **Stds & Ctrl** tab.
2. In the **Installed Kits And Lots** section, choose the kit or lot you want to delete, then click **Delete**.
3. Click **Yes** in either the **Delete Std/Ctrl Kit(s) Confirmation** or **Delete Lot(s) Confirmation** dialog box.

Invalidate Standards and Controls

NOTE: It is possible to invalidate or remove a control in data analysis. However, Luminex does not recommend invalidating controls.

For information on assay controls and guidelines for accepting or rejecting control values, contact the assay kit manufacturer.

To invalidate standards, controls, and samples:

1. Navigate to the **Results** page > **Saved Batches** tab.
2. Choose the completed batch, then click **Open**.
3. In the **Results** section on the **Results** subtab, click the square area to the left of the well you want to invalidate and click **Invalidate**. The whole row turns red. Or click the analyte results in a well and click **Invalidate**.

NOTE: Select the same item and click **Validate** to remove the invalidation status.

4. If quantitative analysis setting were used, then an **Analyze** option will appear after **Invalidate** is clicked. Click **Analyze**.

Validate Standards

Your xPONENT® system administrator must give you privileges to validate standards if you are using the Secure xPONENT® package. All standards are assumed to be valid unless explicitly invalidated.

1. Navigate to the **Results** page > **Saved Batches** tab.
2. Choose the completed batch, then click **Open**.
3. In the **Results** section, click the square area to left of the well you want to validate and click **Validate**.

NOTE: Average rows or cells cannot be selected. If you have not selected an item or the item you selected does not need to be validated, a warning dialog box displays.

Define the Samples

Create a New Sample List

NOTE: Creating a new sample list is intended for Laboratory Information System (LIS) users. If you are not using an LIS, you may want to import a sample list when creating the batch or editing the protocol.

1. Navigate to the **Samples** page > **Samples** tab.
2. In the **Sample Lists** section, choose the protocol you are using for the sample list, then click **Create New Samples**.

3. Add the following information for your sample in the Create Sample subtab:
 - a. Enter the sample ID in the **ID** field.
NOTE: Sample IDs are limited to 30 characters.
 - b. Enter a patient first name in the **First Name** field (optional).
 - c. Enter a patient last name in the **Last Name** field (optional).
 - d. Enter a comment in the **Comment** field (optional).
 - e. Click **Save** to add the sample to the **Sample** list.
4. Click **New** to create more samples or **Edit** to edit the sample.
5. Click **Close** after you add your samples.
NOTE: Samples can also be added using an LIS.

Edit a Sample List

1. Navigate to the **Samples** page > **Samples** tab.
2. In the **Sample Lists** section, choose the protocol you want to edit, then click **Details**.
3. Choose a sample in the **Edit Samples** subtab, then use the **Move** arrows to move the sample up or down in the sample list, changing the order in which the samples will be acquired.
4. Click **Edit**.
5. Edit the appropriate fields or click **Undo** to undo any changes.
6. Click **Save** when you are done editing the sample.
7. Click **Close** when you have completed editing the sample.

Define the Batch

Create a New Batch from an Existing Protocol

When running a kit with a provided protocol, the protocol for the assay must be run as instructed in the assay's package insert.

1. Navigate to the **Batches** page > **Batches** tab > click **Create a New Batch from an existing Protocol**.
2. Enter the batch name in the **Batch Name** field.
3. Enter a description about the batch in the **Enter Optional Description** field.
4. Choose a protocol in the **Select a Protocol** list.
5. Click **Next**. If the protocol uses standards, controls, or both, the **Stds & Ctrls** subtab displays the details of the active reagents. Click **Next**. If the chosen protocol does not use standards or controls, the **Plate Layout** subtab displays.
6. Assign standards, controls, samples, or well commands for this batch on the **Plate Layout** subtab.
 - a. If you need to define a replicate count, choose the **Replicate Count** before adding a well command.
 - i. Choose the **Grouping** - 123123123 OR 111222333 - to define how the replicate count is laid out in the plate wells. Grouping selection must be made before adding a well command.
 - b. In the plate image, click and drag to highlight a series of wells, click a column or row header to highlight the entire column or row, or click and highlight different wells and then click a command to

assign that command to the highlighted wells. Each command is associated with a color.

- i. Before adding well commands, delete all standards from the plate layout if any of the standards need to be rearranged. Delete all controls from the plate layout if any of the controls need to be rearranged.
 - ii. If you need to change the acquisition order of a command in the plate, select the command in the **Command Sequence** list, and click the **Move Command** arrows, up or down.
 - iii. To begin acquisition at a well other than A1, select the well you want to begin acquisition, and click **Start at Well**.
- c. Select a well and then choose **Add**, **Delete**, **Pre-Batch Routine**, or **Post-Batch Routine**, as applicable.

NOTE: Wells and commands you assign to the protocol plate layout are saved into the protocol settings and execute each time you use the protocol to run a batch. Standards and controls associated with a given protocol typically remain constant, while the number of unknown wells often varies. You can assign a specific number of unknown wells to the plate when setting up a batch.

NOTE: If you need to add multiple plates to the batch, click Add Plate to add another plate.

7. Specify the direction to run the plate commands by selecting either vertically or horizontally. The selected direction also dictates how wells are added to the plate when assigning multiple unknowns, standards, and controls at one time.
8. Click **Run Batch** to begin batch acquisition, or click **Save** to save batch information to the **Pending Batch** list to be run at a later time.
 - a. If the batch spans more than one plate, the tray ejects automatically when all defined wells have been acquired. A dialog box displays, prompting you to insert the next plate.

Create a Multi-Batch

The Multi-batch feature automatically sets the batches side-by-side if space remains on the plate. Ensure that the batches fit on one plate. If space limitations create an overlap, an error message displays. Results for each batch are saved as individual batch files. Batches must be created first, before they can be combined on one plate to create a multi-batch.

NOTE: There is a limit of 96 batches in a multi-batch.

NOTE: You cannot add a batch that forces multiple plates to a multi-batch operation. All batches must use the same plate name previously defined and adjusted.

1. Navigate to the **Batches** page > **Batches** tab > click **Create a New Multi-Batch**. The **New Multi-Batch** subtab displays.
 - a. If the **Select Pending Batch** dialog box displays, choose the batch you want to add to the new multi-batch list.
 - b. Click **OK**.
2. Click **Add** to add a batch. The **Select Pending Batch** dialog box displays.
3. Choose a batch from the available options, including batches newly created.
4. Click **OK**. The selected batch will then display on the plate layout.

NOTE: After you add each batch, the software automatically adds the next batch to the first well of the next column or row (depending on the plate direction). You can also select a well first, which places the next batch in your chosen location.

NOTE: If the batches chosen do not fit on the plate, a Multi-Batch Error dialog box opens, indicating you must edit one or more of the selected batches.

Save a Multi-Batch

After creating a multi-batch, save it to the Pending Batches list. When saved to this list, the protocol appears as Multi-Batch.

1. Navigate to the **Batches** page > **Batches** tab.
2. Choose a pending multi-batch and click **Edit**. The **New Multi-Batch** subtab displays.
3. Enter the name for the multi-batch in the **Multi-Batch Name** field.
4. Click **Save**. The multi-batch is now added to the pending batches list.

Edit a Batch

1. Navigate to the **Batches** page > **Batches** tab.
2. In the **Pending Batches** list, choose the batch you want to edit, then click **Edit**. The **Protocol** subtab displays.
3. Enter a new **Batch Name** and **Description**, if needed.
4. Choose a protocol and click **Next**.
5. Edit the information as needed on the **Stds & Ctrls** and **Plate Layout** subtabs. On the **Plate Layout** subtab, confirm that the plate layout conforms to your specific assay instructions.
6. Click **Save** on the **Plate Layout** subtab.

NOTE: Batches saved to a multi-batch cannot be edited unless they are removed from the multi-batch.

NOTE: Only run a batch from the Batches page > Batches tab.

Import a Batch

You only need to import batches to the system once. Enter the lot information for the standard and control reagents as specified in the protocol. This lot information is used for every batch set up using the protocol, until it is changed.

1. Navigate to the **Batches** page > **Batches** tab > click **Import**. The **Import Batch** dialog box displays.
NOTE: Batch files are MDF files. The MDF file allows importing batch data from one xPONENT® to another.
2. Click **Browse**. The **Select File** dialog box displays.
3. Navigate to the batch file you want to import, then click **Open**.
4. Click **OK**. The batch displays in the **Pending Batches** list.

Export a Batch

1. Navigate to the **Batches** page > **Batches** tab.
2. In the **Pending Batches** list, choose the batch you want to export, then click **Export**. The **Export Batch** dialog box displays.
NOTE: You can export batches, but not multi-batches.
3. Click **Browse**. The **Select File** dialog box displays.
4. Navigate to the location where you want to save the file, then click **Save**.
NOTE: If you plan to replay this batch in the future, be sure to include the raw (.lxb) files.

5. In the **Export Batch** dialog box, select **Overwrite** to overwrite the previous file that you may have exported.
6. In the **Export Batch** dialog box, click **OK**.
NOTE: When exporting a large batch and including the LXB files, the export process may take 10 minutes or more.
7. When the export is complete, click **OK** in the **Export Batch** File dialog box.

Delete a Batch

You can only delete unprocessed batches. Batches are deleted from the **Open Batch** list and moved to the **Open Incomplete Batch** list.

1. Navigate to the **Batches** page > **Batches** tab.
2. In the **Pending Batches** list, choose the batch you want to delete, then click **Delete**.
3. Click **Yes** in the **Delete Pending Batch** dialog box.
NOTE: Batches saved to a multi-batch cannot be deleted unless they are removed from the multi-batch. To remove a batch from a multi-batch, click a well in the plate layout, then click **Remove**.
NOTE: You can remove a batch that includes results only through the Archive Utility.

Run a Pending Batch

1. Navigate to the **Batches** page > **Batches** tab.
2. Choose the pending batch that you want to run, then click **Run**.
NOTE: If the batch spans more than one plate, the instrument automatically ejects the first plate after acquiring all of the wells. Insert the next plate when the dialog box prompts you to.

Run the Post-Batch Routine

A Luminex Post-Batch routine automatically runs at the end of each batch to clean the sample chamber and maintain peak system performance. This cannot be deleted or modified and runs by default. However, you can turn off this routine or use a different routine.

1. Navigate to the **Maintenance** page > **Cmnds & Routines** tab.
2. From the **Routine Name** drop-down menu, choose **Post-Batch Routine (Luminex)**.
3. Choose the **Plate Name** from the drop-down menu.
4. Click **Eject**.
5. Add the reagents - distilled water, 70% isopropanol or 70% ethanol, and sodium hydroxide (0.1N NaOH).
6. Click **Retract**.
7. Click **Run**.

Chapter 7: Analyzing the Results

View the Results

1. Navigate to the **Results** page > **Current Batch** tab.
2. On the **Current Batch** tab you can view results, statistics, and log information related to the current batch, and perform statistical analysis on the batch results.

View Sample Details

1. Navigate to the **Results** page > **Saved Batches** tab.
2. Choose the desired batch from the **Completed Batches** list and click **Open**.
3. Click the **Sample Details** subtab.
4. If you are using a Laboratory Information System (LIS)-licensed package of the software, click **Transmit** to transmit sample details to the LIS database. You can transmit either a single analyte per sample or the entire sample.

View Batch Settings

1. Navigate to the **Results** page > **Saved Batches** tab.
2. Choose the desired batch from the **Completed Batches** list and click **Open**.
3. Click the **Settings** subtab, click the left and right **Page** arrows to view the pages of the batch settings report.
4. If desired, click **Save** to open the **Save As** dialog box.
5. Navigate to the location where you want to save the batch settings report, and click **Save**.
6. In the **Report Save Success** dialog box, click **OK**.

View Batch Logs

1. Navigate to the **Results** page > **Saved Batches** tab.
2. Choose the desired batch from the **Completed Batches** list and click **Open**.
3. Click **Log** on the **Results** tab to open the **Log** subtab.

Generate Reports

1. Navigate to the **Results** page > **Reports** tab.
2. From the **Report** drop-down menu, choose the category of report: Batch, Protocol, Calibration and Verification, Performance Verification, System Log, or Advanced. Depending on what you choose in the **Report** list, the content of the **Type** list changes and other features will display in the window.
3. From the **Type** drop-down menu, choose the specific report type.
 - a. If you chose either a Batch report or a Protocol report, select the specific batch or protocol from the list.
 - b. If the report you chose requires a date range (Calibration and Verification, Performance Verification, and System Log), use the calendars available to establish the date range.
4. Batch reports require a choice of analytes; select them from the **Select Analytes** section. Select them all using the **All** button; clear your selections using the **Clear** button.
5. Click **Generate**. If the report includes multiple analytes, use the arrows above the report to move through the list of analytes.
6. Use the **Zoom** drop-down menu to increase the size of the report.

Export the Batch Results

1. Navigate to the **Results** page > **Saved Batches** tab.
2. Choose the completed batch to export and click **Exp Results**.
3. In the **Save As** dialog box, choose an export destination for the .csv file containing your results.

NOTE: The CSV files are the only human readable files. These files can be opened with Excel or similar program to analyze/view data.
4. Click **Save**.
5. In the **Export Complete** dialog box, click **OK**.

Transmit Results to the LIS

Only approved batches can be transmitted to the Laboratory Information System (LIS). If your software is licensed for LIS use, you can transmit batches to the LIS from the Saved Batches tab.

1. Navigate to the **Results** page > **LIS Results** tab.
2. Select a single analyte or the entire sample.
3. Click **Transmit** to send the results to the LIS.

Reacquire Wells from a Batch

Reacquire is performed at the end of a run if a well needs to be reanalyzed. xPONENT® creates a copy of the original file (this new file contains the reacquired values).

1. Navigate to the **Results** page > **Saved Batches** tab.
2. Choose the completed batch from the **Completed Batches** table.
3. Click **Reacquire**.
4. Select the **Reacquire** check box for the desired well(s) on the **Results** subtab.
5. Click **Run** to have the instrument reanalyze the well(s) selected.
6. Click **Yes** on the **Save Copy of Original Batch** dialog box. You also have the option to change the file name.

Replay a Batch

Replaying a batch uses the raw bead data files from the initial acquisition to reanalyze the batch, and creates a new batch output file. The bead data files are replayed using the analyte, analysis settings, and plate layout selected in the new batch or protocol. Settings such as Bead Type, Volume, and XY Heater have no effect.

Results from replaying a batch are generated with new .lxb and .csv files.

Replaying a large batch can take one hour or more to complete. Allow adequate time for the operation to complete; batch replay cannot be stopped while in progress. The operation is complete when all progress bars have disappeared.

A batch can be reanalyzed multiple times. When you replay or recalculate a batch, you perform the same steps to create the batch as you did when you created the batch the first time. The initial batch data and output file always remain intact and unchanged. Each time you replay a batch, the system handles it as if it is new data, and creates a separate batch entry and output file.

If you choose to replay a batch that was originally run without a saved protocol, you have to modify the settings. After you have modified the settings, click **Replay Batch** on the **Plate Layout** subtab to perform the replay or recalculate procedure.

If the system crashes but the plate finished, the data can be recovered by replaying the batch.

1. Navigate to the **Results** page > **Saved Batches** tab.
2. Choose the batch to replay in the **Completed Batches** section, and click **Replay**. This opens the **Select Replay Mode** dialog box. By default, **Recalculate data** is selected, select **Replay Batch**. Click **OK**.

NOTE: When replaying data, if there is a saved protocol associated with the batch, the **Protocols** subtab will display. Select the preferred protocol to replay batch MFI values. If an amended or new protocol is needed, create the protocol before replaying the batch data. If there is not a protocol associated with the data, the **Settings** subtab will display to create a protocol. Analysis settings and plate layout are required by xPONENT® to replay batch MFI values.

NOTE: After you have approved a batch, the status of the batch changes to **Approved** in the **Completed Batches** list.

3. Enter a batch name and description on the **Settings** subtab.

NOTE: You cannot edit the **Acquisitions Settings**.

4. Edit the **Analysis Settings** section as needed to create a new protocol.
5. Click **Next**.
6. Edit the necessary information on the **Analytes** subtab.
7. Click **Next**.
8. Edit the necessary information on the **Stds & Ctrl**s subtab.
9. Click **Next**.
10. Edit the necessary information on the **Plate Layout** subtab.
 - a. Choose the wells you wish to replay on the Plate Layout subtab. Only wells previously read will be available to replay.
11. Click **Replay Batch**.
12. Click **OK** once the batch is complete.

Recalculate Batch Data

Recalculating data reanalyzes the batch results using only the batch's MFI values.

The batch MFI values will be recalculated using the analysis settings and plate layout selected in the new recalculated batch or protocol. Settings such as Volume, Timeout, and XY Heater have no effect. Because only the MFI values are reanalyzed, no data will be displayed in the dot plot. Recalculating data from a large batch can take one hour or more to complete.

1. Navigate to the **Results** page > **Saved Batches** tab.
2. Choose the data to recalculate in the **Completed Batches** section, and click **Replay**.
3. Ensure **Recalculate data** is selected in the **Select Replay Mode** dialog box and click **OK**.

NOTE: When recalculating data, if there is a saved protocol associated with the batch, the Protocols subtab will display. Select the preferred protocol to recalculate batch MFI values. If an amended or new protocol is needed, create the protocol before recalculating the batch data. If there is not a protocol associated with the data, the Settings subtab will display to create a protocol. Analysis settings and plate layout are required by xPONENT® to recalculate batch MFI values.
4. Enter a name and description for the batch.
5. Choose a protocol with the data you want to recalculate from the **Select a Protocol** section.
6. Click **Next**.
7. Edit the necessary information on the **Stds & Ctrl**s subtab.
8. Click **Next**.
9. Edit the necessary information on the **Plate Layout** subtab.
 - a. Choose the wells you wish to recalculate on the Plate Layout subtab. Only wells previously read will be available to replay.
10. Click **Replay Batch**.

Chapter 8: Troubleshooting

Troubleshooting procedures help users isolate, identify, and remedy problems with the system. This chapter does not troubleshoot problems with the PC. For help with PC problems, please contact the technical support system for your PC's manufacturer.

Generate and Send the Support Utility File

The Support Utility tab creates a support file that you can send to Technical Support. The file also contains calibration and verification reports.

NOTE: Ensure the instrument is powered on and connect to xPONENT® before generating a Support Utility File.

1. Navigate to the **Maintenance** page > **Support Utility** tab.
2. Choose the batch you want to generate a support utility file for, and then select the **Include Batch Information** check box to include the batch information with the support file.
3. Click **Support** to launch the **Support Utility** dialog box.
4. Enter your name in the **Name** field.
5. Enter your company name in the **Company Name** field.
6. Enter your phone number in the **Phone Number** field.
7. Enter your email in the **Email** field.
8. In the **Comment** field, type a detailed description of the problem you are experiencing.
9. In the **Directory Configuration** section, verify the location where you want to store the file in the **Output Directory** field.
 - a. To change the location, click **Browse**, then navigate to the new folder and click **OK**.
10. Click **Save File**. The saved file includes date and time information.
11. In the **Save As** dialog box, enter the file name and then click **Save**.
12. Send an email to support@luminexcorp.com and attach the support file (xPONENTSupportFile.zip) to the email.

NOTE: You can save and/or print the report, if desired.

Calibration/Performance Verification Failures

Calibration Failure

Calibration problems can result from a variety of causes, many of them easily correctable human errors.

Table 1. Calibration Failure

Problem	Corrective Action
Possible Calibration Microsphere Causes:	
The calibration microspheres are not fully resuspended.	Vortex the calibration vials to re-suspend the microspheres.
The wrong lot number or target values were entered in the software.	Correct the lot number and target values in the software.
The calibration microspheres are in the wrong well.	Change the well setting in the software.
There are not enough calibration microspheres in the well.	Add at least five drops of calibration microspheres to the well. For accurate drop volume, hold the vial upside down at a 90 degree angle to the plate while dispensing them.
You are using the incorrect calibration microspheres.	Use the xMAP® MAGPIX® Calibration Kit.
The calibration microsphere lot is expired.	Substitute an unexpired bottle of calibrator microspheres.
Possible Sample Probe Causes:	
The sample probe height is incorrect.	Perform an automatic sample probe height adjustment.
The sample probe is clogged.	Refer to topic Troubleshooting > Clogs.
The probe fitting is loose.	Tighten the probe fitting.
Other Possible Causes:	
There is a partial clog in the instrument.	Refer to topic Troubleshooting > Clogs.
There is air in the instrument.	Perform an automatic sample probe height adjustment. Use the software to run a prime command three times, an alcohol flush command twice, then a wash command three times with distilled water.
	Make sure the drive fluid coil is not pinched.
The sample valve is faulty.	Contact Luminex Technical Support.

Problem	Corrective Action
There is a problem internal to the instrument.	Review the log of calibration reports. Check for dramatic changes in temperature or voltage. If any of these are present, contact <i>Luminex Technical Support</i> .
No events are being collected during calibration.	Check the drive and waste fluid levels. Verify that tubing for both bottles is tightly connected to the instrument. Check that the waste bottle cap is vented.
	Check for sample probe problems.

Performance Verification Failures

Verification problems can have a variety of causes, many of them easily correctable human errors.

Table 2. Performance Verification Failures

Possible Causes	Corrective Action
Possible Verification Microsphere Causes:	
The verification microspheres are not fully suspended.	Vortex the verification vials to re-suspend the microspheres.
The wrong lot number or target values were entered in the software.	Correct the lot number and target values in the software.
The instrument verification microspheres are in the wrong well.	Change the well setting in the software.
There are not enough verification microspheres in the well.	Add at least five drops of verification microspheres to the well. For accurate drop volume, hold the vial upside down at a 90 degree angle to the plate while dispensing them
You are using the incorrect verification microspheres.	Verify that you are using the MAGPIX® Performance Verification Kit.
The verification lot is expired.	Use an unexpired bottle of verification microspheres.
The verification microspheres have been diluted.	Substitute undiluted verification microspheres.
The verification microspheres are photobleached.	Use a different bottle of verification microspheres, one that has been protected from light during storage.
Possible Sample Probe Causes:	

Possible Causes	Corrective Action
The sample probe height is incorrect.	Perform an automatic sample probe height adjustment.
The sample probe is clogged.	Refer to topic Troubleshooting > Clogs.
The sample valve is faulty.	Contact Luminex Technical Support.
Other Possible Causes:	
There is carryover from the calibrators or the previous assay.	Refer to topic Troubleshooting > Carryover Problems.
Air is in the instrument.	Verify the sample probe height. Run three Prime commands, two Alcohol Flush commands, and three Wash commands with distilled water.
	Make sure the drive fluid coil is not pinched.
There is a problem internal to the instrument.	Review the log of calibration reports. Check for dramatic changes in temperature or voltage. If any of these are present, contact Luminex Technical Support.
The waste line was moved during instrument operation, resulting in an unstable flow rate.	Stabilize the waste line during instrument operation.

Carryover Calibration Problems

Carryover from calibration can interfere with verification; likewise, carryover from an assay can interfere with correct reading of the following assay. Take the following steps to eliminate carryover:

- Begin by performing four rinse cycles.
- If that fails, run the Clean command twice using a sodium hydroxide solution (0.1N NaOH).
- If running the Clean command twice fails, run the Enhanced Startup Routine.

Instrument Errors

Communication Problems

Communication problems described in this section involve the links between the data system (PC and software) and MAGPIX®.

The term “Communication” refers to:

- The transfer of data between the PC and the MAGPIX.
- The current status of the MAGPIX.
- Instrument control, sample acquisition, session uploading, and start, stop and pause features.

Table 3. Communication Problems

Problem	Possible Causes	Corrective Action
The PC cannot establish a connection with MAGPIX.	The communication cable is unplugged or plugged into the wrong port.	Plug in or move the communications cable.
	The MAGPIX is not turned on.	Turn off the PC. Turn on the MAGPIX and then turn on the PC.

Power Supply Problems

Power supply problems often involve a blown fuse, faulty electronic component, or disconnected cable.



Whenever you deal with a potential electrical problem, be careful to avoid electrical shocks.

Table 4. Power Supply Problems

Problem	Possible Cause	Corrective Action
MAGPIX® will not turn on.	The power cord is disconnected.	Plug in the power cord.
	The hard power switch on the back of the instrument is not turned on.	Turn on the switch.
	No voltage is coming from the electrical outlet.	Change to a different outlet. If MAGPIX is plugged into a surge protector, make certain the surge protector is turned on.
	The power supply is faulty.	Contact Luminex Technical Support
	A fuse has burned out.	Replace the fuse.
Fuses continue to open (blow).	A component has a short circuit.	Contact Luminex Technical Support

Fluid Leaks

There are numerous places in MAGPIX® where fluid can leak. Most leaks can be easily fixed; for the remainder, contact *Luminex Technical Support*.

Table 5. Fluid Leaks

Problem	Possible Cause	Corrective Action
Fluid is pooled around the MAGPIX®.	Fittings, fluid tubes, or components are damaged, loose, or faulty.	Turn off and disconnect the instrument to avoid electrical shock. Check for possible sources of leaking and correct them. If leaking continues, contact <i>Luminex Technical Support</i> .
Fluid leaks within the instrument:		
A fluid tube leaks.	The tube is damaged.	If it is the sample probe tube, replace it. Otherwise, contact <i>Luminex Technical Support</i> .
The waste bottle leaks.	The waste bottle fitting is loose.	Reset the waste bottle fitting.
The drive fluid filter leaks.	The drive fluid filter fittings are loose.	Hand-tighten the drive fluid filter fittings.
The sample probe leaks.	The sample probe is clogged.	Refer to topic Troubleshooting > Clogs.
	The sample probe is loose.	Tighten the fitting.
The sample valve leaks.	The sample valve has one or more loose fittings.	Hand-tighten the sample valve fittings.
	The sample valve is faulty.	Contact <i>Luminex Technical Support</i> .
The syringe seal leaks.	The seal is worn out or faulty.	Replace the syringe seal.
The syringe valve leaks.	The valve is loose or faulty.	Hand-tighten the syringe connection (silver knob) on the syringe valve. Run a Prime command. If leaking continues, contact <i>Luminex Technical Support</i> .

Low Bead Count

Clogs

Often, a clog somewhere in the MAGPIX® is the cause of a problem with calibration, verification, or data acquisition. To determine if there is a clog, run performance verification to see if the fluidics function is operating properly. In the event you encounter a problem that is clog-related, use the following procedure.

To troubleshoot a possible clog:

1. Clean and adjust the sample probe.
2. Remove the clogs.
3. Run calibration and verification.

If this procedure is unsuccessful, contact *Luminex Technical Support*.

Sample Probe Problems

Problems with the sample probe can lead to fluid leaks acquisition failure.

Table 6. Sample Probe Problems

Problem	Possible Causes	Corrective Actions
The sample probe leaks.	The sample probe is clogged.	Refer to topic Troubleshooting > Clogs.
	The sample probe is loose.	Tighten the fitting.
The sample arm is stuck in the up or down position.	The sample probe motor connections are loose.	Contact <i>Luminex Technical Support</i> . Check pressure settings.
	The sample probe motor is faulty.	Contact Luminex Technical Support.
The sample arm does not go down smoothly.	The plate is incorrectly seated.	Adjust the plate.
	The plate is warped.	Replace the plate.
	The sample probe is bent.	Remove the sample probe from the instrument and roll it on a clean, flat surface. If a sample probe has been bent and rolled straight more than once, discard it and replace with a new sample probe. Adjust the sample probe height.

Acquisition Failures

Acquisition failure can result from many of the same causes as calibration and verification failure, in addition to sample and volume problems.

Table 7. Acquisition Failures

Problem	Corrective Actions
Possible xMAP® Microsphere Causes:	
The xMAP microspheres are not fully suspended.	Gently vortex the plate or resuspend microspheres with a multichannel pipette to ensure that the microspheres are present in the solution.
The wrong lot number or target values are entered in software.	Correct the lot number and target values in the software.
The wrong wells are selected for the xMAP microspheres.	Change the well setting in the software.
The xMAP microspheres have expired.	Substitute an unexpired bottle of xMAP microspheres.
The xMAP microspheres are photobleached.	Substitute xMAP microspheres that are not photobleached.
Possible Sample Probe Causes:	
The sample probe height is incorrect.	Perform an automatic sample probe height adjustment.
The sample probe is clogged.	Refer to topic Troubleshooting > Clogs.
Other Possible Causes:	
The drive fluid or waste line is not fully connected.	Disconnect and reconnect the lines.
Air is present in the instrument.	Verify the sample probe height. Use the software to run a prime command three times, an alcohol flush command twice, then a wash command three times with distilled water.
	Make sure the drive fluid coil is not pinched.
The acquisition volume is set too high.	Set the acquisition volume to at least 25 µL less than the actual volume in your wells. This enables the probe to acquire sample more efficiently with less chance of incorporating air in the sample.
The sample is too concentrated.	Dilute concentrated biological fluids, such as serum or plasma, at least 1:5.

Bead Detail Irregularities

Use these tools to assist in diagnosing instrument and assay-related problems:



- System calibrators
- MAGPIX® performance verifiers
- Assay standards
- Assay controls
- Error messages



Review the log of calibration reports routinely to detect trends.

Use MAGPIX performance verifiers to check the success of the instrument calibration and to troubleshoot. If there is a problem with assay results, MAGPIX performance verifiers can help determine if the problem is related to the instrument. If calibration and verification are successful, contact the assay manufacturer.

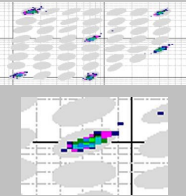
The following table identifies the three possible categories of microsphere dot plots: normal, irregular due to photobleaching of the microspheres, and irregular due to MAGPIX being out of calibration.

Table 8. Bead Details

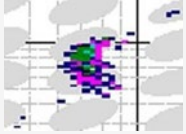
Appearance	Description	Possible Problem	Solution
Normal Bead Grouping			
	MagPlex® verifiers form a tight bead population within the boundaries of the gray region.	N/A	N/A
Irregular Bead Grouping: Photobleached Microspheres			
	MagPlex verifiers are outside of their region (below or to the left).	MagPlex verifiers are photobleached.	Reverify with new MagPlex verifiers.
	MagPlex verifiers are outside of their region (above or to the right).	MagPlex calibrators are photobleached.	Recalibrate with new MagPlex calibrators and verify.
Other Irregular Bead Groupings			

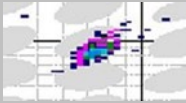
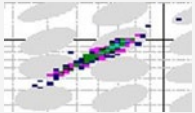
Appearance	Description	Possible Problem	Solution
	The dot plot is elongated, horizontally or vertically, with microsphere scatter.	Incompatible drive fluid or air in the system.	Verify that the system is using MAGPIX Drive Fluid or MAGPIX Drive Fluid PLUS, and verify that it is clear and colorless. Check for tightness on accessible fittings.
	MagPlex microspheres fail to form a tight population within their regions.		
	The dot plot is elongated, horizontally or vertically.	Incompatible drive fluid.	Verify that the system is using MAGPIX Drive Fluid or MAGPIX Drive Fluid PLUS, and verify that it is clear and colorless.
	MagPlex microspheres fail to form a tight population within their regions.		
	MagPlex microspheres fail to form a tight population within their regions, and the dot plot extends diagonally	Incompatible solvents may be present in assay buffer.	Contact <i>Luminex Technical Support</i> to request a list of incompatible solvents. If the solvent you are using is listed, switch solvents.

Run a Self Test

Perform a Self Test to evaluate the hardware component of the system and all operations are functioning properly.

If there is a failure you can try to cycle the power to correct the failure. If that does not fix the issue, then call *Luminex Technical Support*.

1. Navigate to the **Maintenance** page > **Cmnds & Routines** tab.
2. Click **Self Test**.
3. Click **Run**.

Customer Orderable Part Numbers

Table 9. Hardware Part Numbers

Product Description	Customer Number
Access Door Tool	CN-0264-01
Fuse 2AMP 250V Fast Acting (Qty 1)	CN-0019-01
Sample Probe Needle	CN-0221-01
Heater Block, 96 Wellplate	CN-0224-01
Cable, USB (A to B)	CN-0271-01
Air Filter 4.5 x 4.5	CN-0257-01
Drive Fluid Filter	CN-0258-01
Sample-to-Valve Tubing Assembly	CN-0259-01
Off-Plate Reagent Block	CN-0260-01
Waste Bottle Assembly	CN-0261-01
Syringe, 500 µL Ball End	CN-0262-01
Sample Probe Height Adjustment Kit	CN-0263-01
Barcode Scanner	CN-PC03-01
Cable, Power	CN-PXXX-01*

* XXX is a country specific part number. For more information, contact *Luminex Technical Support*.

Table 10. Reagent Part Numbers

Product Description	Customer Number
MAGPIX® Calibration Kit, 25 Uses, IVD	MPXIVD-CAL-K25
MAGPIX® Performance Verification Kit, 25 Uses, IVD	MPXIVD-PVER-K25
MAGPIX® Drive Fluid PLUS 4 Pack, IVD	40-50020

Chapter 9: Maintaining the System

To ensure accurate test results, properly clean and maintain the MAGPIX®. Read and follow all instructions in this chapter. To facilitate your maintenance process, print out and use the *Maintenance Log*.

General Maintenance Precautions

Observe the following general maintenance precautions.



Personnel who use, maintain, or clean the MAGPIX® should be trained in standard laboratory safety practices and should follow those practices when handling the instrument.

Samples and waste fluid can contain biohazardous material. Where exposure to biohazardous material, including in an aerosol form, exists, follow appropriate biosafety procedures, use personal protective equipment (PPE), and use ventilation devices.

Avoid contact with moving parts. Disconnect the instrument from the power source when the procedure instructs you to do so.

Do not remove the cover of MAGPIX. All maintenance can be performed from the outside of the instrument, within the fluid compartment, or within the compartment that is accessible by opening the side access door.

Maintenance Commands and Routines

Wash	Sends 250 µL of distilled water through the chamber and fluidic lines in the system. It pulls the fluid from a well or reservoir and runs it completely through the system to the waste fluid container.
Clean	<p>Aspirates a cleaning reagent, such as a 0.6% sodium hypochlorite solution with no additives or sodium hydroxide.</p> <p>NOTE: Sodium hypochlorite solutions containing small amounts of sodium chloride (NaCl), sodium carbonate (Na₂CO₃), sodium hydroxide (NaOH), and other pH buffers may be used. Do not use sodium hypochlorite solutions containing film-forming agents, such as Diallyldimethylammonium Chloride (DADMAC), or other additives.</p> <p>NOTE: The xPONENT® for MAGPIX® software may refer to a 0.6% sodium hypochlorite solution with no additives as '10% to 20% household bleach'.</p>
Alcohol Flush	Removes air bubbles from the sample tubing and the cuvette using 70% isopropanol or 70% ethanol. The alcohol flush takes about 5 minutes.
Rinse	Re-primed the probe and rinses out the chamber. No reagent is needed but one of the off-plate reservoirs must be empty.
Soak	Perform the soak function at the end of each day. The system uses at least 200 µL of distilled water. Prevents salt crystals from forming in the sample probe due to air exposure. Soaking the sample probe replaces drive fluid in the sample probe with water.
Sanitize	<p>Performs a similar function as the alcohol flush command, but uses a 0.6% sodium hypochlorite solution with no additives to decontaminate sample lines and the cuvette after biohazard contact.</p> <p>NOTE: Sodium hypochlorite solutions containing small amounts of sodium chloride (NaCl), sodium carbonate (Na₂CO₃), sodium hydroxide (NaOH), and other pH buffers may be used. Do not use sodium hypochlorite solutions containing film-forming agents, such as Diallyldimethylammonium Chloride (DADMAC), or other additives.</p> <p>NOTE: The xPONENT® for MAGPIX® software may refer to a 0.6% sodium hypochlorite solution with no additives as '10% to 20% household bleach'.</p>
Prime	Removes air bubbles from the system's fluidic pathways by drawing drive fluid from the drive fluid bottle. You do not need to supply solution in a plate.
Self-Test	Performs a self-diagnostic test to see if the system and all operations are functioning properly. The self-test evaluates the sample delivery and the optics module.
VER	Performs a verification.
CAL	Performs a calibration.
Fluidics	Runs fluidics.

Create a New Maintenance Routine

Create maintenance routines to facilitate your startup procedure, shutdown procedure, troubleshooting, or calibration. Ensure that the maintenance routine you create is consistent with the Luminex® instrument operations and maintenance requirements.

To create a new maintenance routine:

1. Navigate to the **Maintenance** page > **Cmnds & Routines** tab.
2. Choose **None** in the **Routine Name** drop-down menu.
3. Choose the plate in the **Plate Name** list to use for the new routine.
4. In the **Commands** section, click one or more commands to add to the routine. These commands display in the plate image and in the **Command Sequence** list.

NOTE: When you choose the CAL command, a Rinse command is performed prior to the CAL. When the CAL is complete, two additional Rinse commands are performed. This prevents a bubble from loading into the chamber. Verify that you have sufficient room in the reservoir to complete these Rinse commands.

NOTE: When you choose the VER command, a Rinse command is performed prior to the VER. When the VER is complete, an additional Rinse command is performed. This prevents a bubble from loading into the chamber. Verify that you have sufficient room in the reservoir to complete these Rinse commands.

5. To change a location (well or reservoir) for a command, click the command in the **Command Sequence** list, then click the new location in the plate image.

NOTE: If you attempt to place two or more commands in the same well; a message displays instructing you to change the location of the command. Some commands can be run from the same location, for example, multiple washes can be run from the same reservoir.

6. Click **Save As** to save the new routine. The **Save Routine** dialog box displays.
7. Enter the routine name in the **Routine Name** field, then click **OK**.

Run a Maintenance Routine

1. Navigate to the **Maintenance** page > **Cmnds & Routines** tab.
2. Choose a routine from the **Routine Name** drop-down menu.
3. Click **Eject**.
4. Add the appropriate reagents to the plate, reservoirs, and strip wells, as indicated in the plate image and set the plate on the plate holder.
5. Click **Retract**.
6. Click **Run**. The **Routine Message** dialog box displays when the routine is complete.
7. Click **OK**.

Import a Maintenance Routine

1. Navigate to the **Maintenance** page > **Cmnds & Routines** tab > click **Import**.
2. In the **Open** dialog box, browse for the file you want to import, then click **Open**.
3. In the **Import Routine File** dialog box, click **OK**. The routine becomes the active routine.

Edit a Maintenance Routine

1. Navigate to the **Maintenance** page > **Cmds & Routines** tab.
2. Choose a routine from the **Routine Name** drop-down menu.
3. Click a command in the **Command Sequence** list that you want to edit. Click **Clear** to delete the command, or click in a different well in the plate image to change the location of that command.
NOTE: When you add or remove a command, the routine name automatically defaults to None in the Routine Name drop-down menu.
4. Add, delete, or change commands as necessary, then click **Save As**.
NOTE: You can only add commands to the end of a routine. You cannot insert new commands before commands that are already part of a routine.
5. Enter a different name for the routine to create a new routine, or type the existing name of the routine to keep the edited routine using the existing routine name.

Delete a Maintenance Routine

You can delete a routine that you created, but you cannot delete pre-defined routines.

1. Navigate to the **Maintenance page > Cmds & Routines** tab.
2. Choose a routine from the **Routine Name** drop-down menu.
3. Click **Delete**.
4. In the **Delete Maintenance Routine Confirmation** dialog box, click **Yes** to delete.

Export a Maintenance Routine

1. Navigate to the **Maintenance** page > **Cmds & Routines** tab.
2. Choose a routine from the **Routine Name** drop-down menu.
3. Click **Export**.
4. In the **Save As** dialog box, navigate to the folder where you want to store the routine file, then click **Save**.
NOTE: The export option is only available for routines that have been saved.
5. In the **Export Routine** dialog box, click **OK**.

Maintain Instrument Fluids

MAGPIX® has a built-in compartment to hold a single-use disposable drive fluid bottle and a reusable waste fluid bottle. It comes with two waste fluid bottles and a two-pack of drive fluid bottles. All fluid tubing is contained within the instrument.

NOTE: Do not refill or reuse the MAGPIX Drive Fluid or MAGPIX Drive Fluid PLUS bottles.

Monitor fluid levels daily. Replace the empty drive fluid bottle as needed. If MAGPIX operates with an empty drive fluid bottle, the lack of drive fluid may interrupt a sample and prevent further samples from being collected.



Only use MAGPIX Drive Fluid or MAGPIX Drive Fluid PLUS. Use of non-Luminex approved drive fluid shall constitute "Improper Use" and can void the warranty provided by Luminex and/or its authorized partner

Empty the waste fluid bottle whenever it is full. Use the following guidelines:

- Replace the newly emptied waste fluid bottle with the second, dry waste fluid bottle so the moisture remaining in the first waste fluid bottle does not trigger a "waste bottle full" message.
- Before removing the waste fluid bottle, make certain all other fittings and tubes are firmly attached to avoid any contamination from dripping waste fluid.

Replace the Drive Fluid Bottle

1. Open the door of the fluid compartment on the front of the MAGPIX®.
2. Pull the drive fluid bottle out of the compartment and pull the plug out.
3. Open the box of drive fluid bottles and remove one bottle.
4. Insert the drive fluid bottle part of the way into the fluid compartment opening and remove the seal.
5. Connect the drive fluid tube and plug to the opening on the top of the drive fluid bottle.
6. Slide the bottle into the tray on the left side of the fluid compartment. The bottle tray is constructed to hold the bottle in place.
7. After the bottle is fully inserted, check the valve on the front of the waste fluid bottle to make certain it is securely attached and close the door of the fluid compartment.

Empty the Waste Fluid Bottle

Empty the waste fluid bottle, when the bottle is full.

1. Open the door of the fluid compartment on the front of the MAGPIX®.
2. Disconnect the orange waste fluid line from the waste fluid bottle by depressing the silver tab and pulling the fluid line out.
3. Carefully remove the waste fluid bottle from its tray.
4. Unscrew the cap on top of the waste fluid bottle to drain out the fluid.
NOTE: Discard the waste fluid in accord with all local, state, federal, and country-specific biohazard handling regulations.
5. Insert the second, dry waste fluid bottle in the fluid compartment.
NOTE: Make sure the empty waste fluid bottle is dry or the empty bottle will continue to send a "Waste Bottle Full" message.
6. Insert the orange waste fluid line into the waste fluid bottle opening by pushing the fluid line until it clicks into place.



Waste fluid can contain biohazardous infectious agents. Where exposure to potentially biohazardous materials (including aerosol) exists, follow appropriate biosafety procedures and use personal protective equipment (PPE) such as gloves, gowns, laboratory coats, face shields (or mask and eye protection), respirators, and ventilation devices.

Maintain Instrument Hardware

Daily Maintenance

Most of the daily maintenance tasks for MAGPIX® can be performed using available software commands.

Run the Daily Shut-down Routine

System shutdown is a standardized procedure in xPONENT® for MAGPIX® software. It includes sanitize, clean (with sodium hydroxide (0.1N NaOH)), wash, and soak routines.

NOTE: The xPONENT for MAGPIX software may refer to a 0.6% sodium hypochlorite solution with no additives as '10% to 20% household bleach'.



Sodium hydroxide is extremely caustic. If it comes into contact with skin, it can burn and cause tissue damage without causing pain. Always wear gloves and goggles when working with sodium hydroxide.

Run the Daily Shutdown routine to prevent clogs and crystallization of salt in the sample probe. Clogs and crystallization of salt in the sample probe can cause problems with calibration, verification, and data acquisition; they can also cause sample splashing. Shut down the system properly to ensure system integrity.

1. From the **Home** page, click **Shutdown**. The **Auto Maint** tab displays.
2. Click **Eject**.
3. Fill reservoir RA1 3/4 full of DI water.
4. Fill reservoir RC1 3/4 full of a 0.6% sodium hypochlorite solution with no additives.

NOTE: Sodium hypochlorite solutions containing small amounts of sodium chloride (NaCl), sodium carbonate (Na₂CO₃), sodium hydroxide (NaOH), and other pH buffers may be used. Do not use sodium hypochlorite solutions containing film-forming agents, such as Diallyldimethylammonium Chloride (DADMAC), or other additives. Verify that reservoir RD1 is empty.

5. Click **Retract**.
6. Click **Run**.

Shut Down the System



Luminex does not recommend shutting down the MAGPIX® system while a run is in progress. Doing so may cause loss of data.

NOTE: If the Daily Shutdown routine has not been run on the Home page > Auto Maint tab, run this routine before shutting down the system.

1. Remove the plate and any bulk reagents from the instrument.
2. Push the soft power switch on the front of the instrument.
NOTE: The light in the hexagonal window will turn off as confirmation that the power is off.
3. Perform a hard power shutdown by turning off the hard power switch located on the back of the instrument and unplug the instrument.
4. Exit the xPONENT® software.

5. Click **Log Off**, then click **OK** to confirm the logout.
6. Click **Exit**, then click **Yes** to exit the software.
7. Turn off the PC desktop.

Weekly Maintenance

Perform a Visual Inspection

Inspect the MAGPIX® weekly. Make sure the instrument is idle, so there are no moving parts. Open the MAGPIX side access door and fluid compartment door.

- Visually inspect for leaks, corrosion, and other signs of improper function.
- Check all visible tubing connections.

Run the Clean Routine



Sodium hydroxide is extremely caustic. If it comes into contact with skin, it can burn and cause tissue damage without causing pain. Always wear gloves and goggles when working with sodium hydroxide.

1. Navigate to the **Maintenance** page > **Cmnds & Routines** tab.
2. Click the **Clean** command.
3. Click **Eject**.
4. Fill reservoir Clean 3/4 full of sodium hydroxide (0.1N NaOH) in the of the off-plate reagent block.
5. Click **Retract**.
6. Click **Run**.

Clean the Sample Probe



Avoid contact with moving parts. If a plate is running, use the software to execute Stop to avoid the possibility of exposure to moving parts. The system must not be performing any operations while you carry out this maintenance procedure.

To clean the sample probe:

1. Click **STOP** if a plate is running.
2. Turn off the MAGPIX® and unplug the power cord.
3. Remove the sample probe.
 - a. Open the side access door of the MAGPIX .
 - i. Insert the tool in the side access door latch and turn it one quarter turn clockwise. Slide the door to the right.
 - b. Lower the sample probe assembly.
 - c. Unscrew the sample probe fitting on top of the probe completely.
 - d. Grasp the sample probe gently and push up.
 - e. Lift the sample probe out of the top of the sample probe holder.

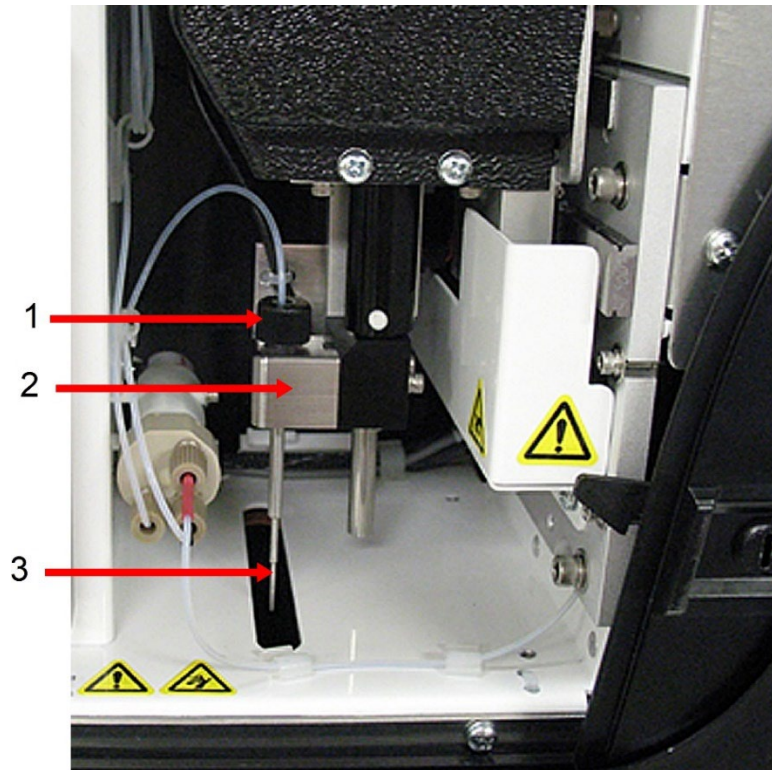

- | | |
|----|--|
| 1. | Sample probe fitting (Unscrew and remove) |
| 2. | Sample probe assembly |
| 3. | Sample probe (Push up gently and lift out of holder) |

4. Clean the sample probe using a bath sonicator or a 10 mL syringe. If you are using a bath sonicator, place the tip of the sample probe in the bath sonicator for 2 to 5 minutes of water flowing through the sample probe syringe or place the sample probe in a clean tube containing water which will then be placed in a bath sonicator. If you are using a syringe, force deionized water through the tip of the sample probe and out the large end. This dislodges any debris clogging the tip.
5. Replace the sample probe and tightly screw in the sample probe fitting until it clicks.
6. Perform an automatic probe height adjustment.

NOTE: Perform an automatic probe height adjustment any time the sample probe is reinstalled after removal.

Remove Clogs



Sodium hydroxide is extremely caustic. If it comes into contact with skin, it can burn and cause tissue damage without causing pain. Always wear gloves and goggles when working with sodium hydroxide.

If you frequently use the MAGPIX® to test concentrated serum or other debris-ridden samples, Luminex recommends that you perform a clog removal weekly. Otherwise, perform this procedure as needed.

To remove clogs:

1. Navigate to the **Maintenance page > Cmds & Routines** tab.
2. Click the **Clean** command.
3. Click **Eject**.
4. Fill reservoir Clean 3/4 full of sodium hydroxide (0.1N NaOH) in the of the off-plate reagent block.
5. Click **Retract**.
6. Click **Run**.

Monthly Maintenance

Clean the Exterior Surfaces

NOTE: The xPONENT® for MAGPIX® software may refer to a 0.6% sodium hypochlorite solution with no additives as '10% to 20% household bleach'.

1. Turn off the MAGPIX® and unplug the power cord.
2. Clean all exterior surfaces with a mild detergent, followed by a 0.6% sodium hypochlorite solution with no additives, followed by distilled water.

NOTE: Sodium hypochlorite solutions containing small amounts of sodium chloride (NaCl), sodium carbonate (Na₂CO₃), sodium hydroxide (NaOH), and other pH buffers may be used. Do not use sodium hypochlorite solutions containing film-forming agents, such as Diallyldimethylammonium Chloride (DADMAC), or other additives.

3. Open the side access door of the instrument.
 - a. Insert the tool in the side access door latch and turn it one quarter turn clockwise. Slide the door to the right.
4. Clean all accessible surfaces with detergent, followed by a 0.6% sodium hypochlorite solution with no additives, followed by distilled water.

NOTE: Sodium hypochlorite solutions containing small amounts of sodium chloride (NaCl), sodium carbonate (Na₂CO₃), sodium hydroxide (NaOH), and other pH buffers may be used. Do not use sodium hypochlorite solutions containing film-forming agents, such as Diallyldimethylammonium Chloride (DADMAC), or other additives.



Avoid contact with the tubing and electronic parts of the instrument.

5. Dry any unpainted metal surfaces to prevent corrosion and then close the side access door.
6. Plug in the power cord and turn on the MAGPIX.

Semi-Annual Maintenance

Clean the Air Filters

MAGPIX® has two air filters, one on the bottom of the instrument and one on the back of the instrument. Every six months, remove these air filters, clean them, and reinstall them.

To clean MAGPIX air filters:

1. Turn off MAGPIX and unplug the power cord.
2. Slide the back filter up out of its holder.
3. Lift MAGPIX and slide the bottom filter out of its holder toward the front of the instrument.



Before removing the bottom air filter, remove both the waste fluid and drive fluid bottles, the off-plate reagent block, and any plates in the instrument.

4. Clean the filters with a vacuum or with distilled water. Stand the filters upright to air dry.



Filters must be completely dry prior to re-installation.

5. Locate the small incised arrow on the frame of the filter. This indicates air flow. The filter must be installed with the arrow pointing inward.



6. Reinstall the filters.
7. Plug in the power cord and turn on MAGPIX.

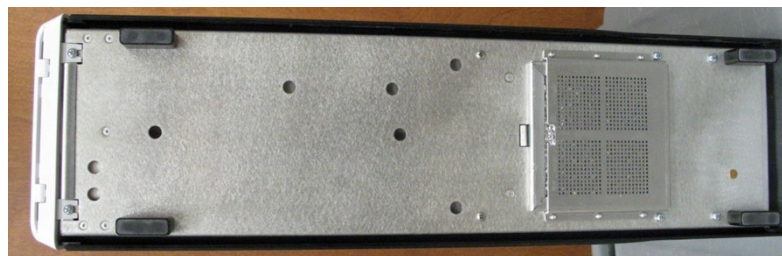

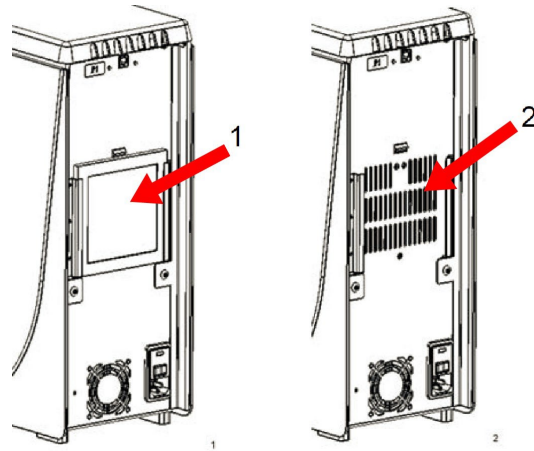

- | | |
|----|-----------------------|
| 1. | Before Filter Removal |
| 2. | After Filter Removal |

Replace the Syringe Seal

When you replace a syringe seal, also replace the black O-ring that fits inside it. One package contains four of each.

1. Turn off the MAGPIX® and unplug the power cord.



The plunger guide does NOT deactivate while the seal is being changed; unplugging is necessary to avoid injury.

2. Open the side access door of the MAGPIX.
 - a. Insert the tool in the side access door latch and turn it one quarter turn clockwise. Slide the door to the right.
3. Locate the syringe (glass cylinder with a metal rod plunger).
4. Push the plunger guide down. The syringe may fill with clean drive fluid.

NOTE: The plunger guide is tight. Be prepared to use some force to push it down.
5. Unscrew the syringe from the top of its housing and carefully remove it.
6. Pull the plunger out of the syringe and dispose of any drive fluid.
7. Using a pair of pliers, remove the white plunger seal (at the top of the plunger) and discard it.
8. Place the black O-ring inside the new white plunger seal and press the seal down on the top of the plunger.
9. Return the plunger to the syringe.
10. Screw the syringe back into its housing.

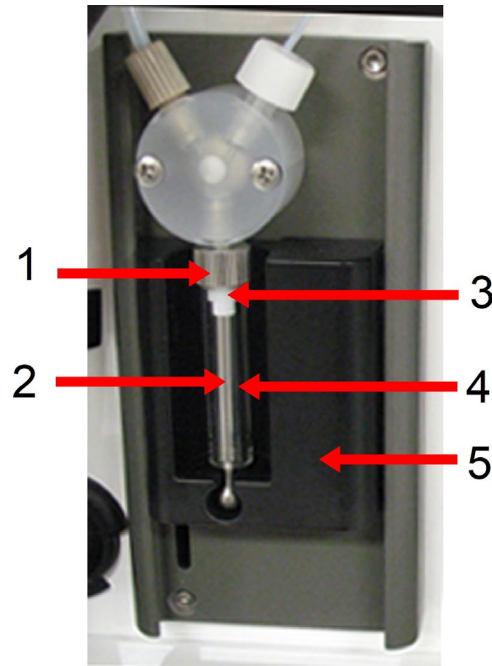

1.	Syringe Housing	4.	Glass Cylinder
2.	Metal Rod Plunger	5.	Plunger Guide
3.	Syringe Seal (contains black O-ring)		

11. Return the plunger guide to its original position. The bottom of the plunger fits into the indentation in the plunger guide.
12. Plug in the power cord and turn on MAGPIX.
13. Run two **Prime** commands, and watch for any leaks in the syringe area.
14. Close the side access door.

Annual Maintenance

Replace the Drive Fluid Filter

To replace the drive fluid filter on MAGPIX®:

1. Turn off MAGPIX and unplug the power cord.
2. Open the side access door and locate the drive fluid filter at the left of the syringe pump.
 - a. Insert the tool in the side access door latch and turn it one quarter turn clockwise. Slide the door to the right.
3. Gently pull the filter from the mounting bracket.
4. Unscrew the **Top Tube Attachment** and the **Bottom Tube Attachment** from the top and bottom of the filter.
5. Ensure that the drive fluid filter orientation (top and bottom) matches the image and reattach the tubing to

the ends of the new filter. Tighten both fittings until they click.

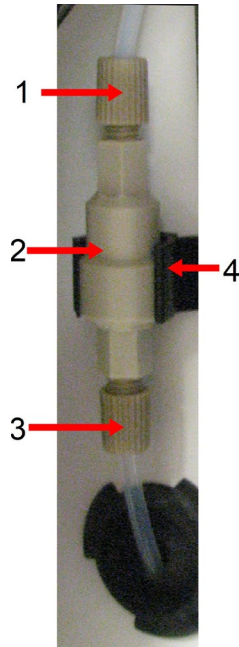

1.	Top Tube Attachment	3.	Bottom Tube Attachment
2.	Filter	4.	Mounting Bracket

6. Press the new filter into the mounting bracket.
7. Close the side access door.
8. Plug in the power cord and turn on the MAGPIX.
9. Use the software to run the prime command twice. Ensure that the drive fluid is being pulled into the syringe during the Prime.

Replace the Sample Probe Tube

The tube that connects the sample probe to the valve is subject to wear because of the constant motion of the sample probe. Replace the sample probe tube on a yearly basis.

Figure 15: Sample Probe Tube

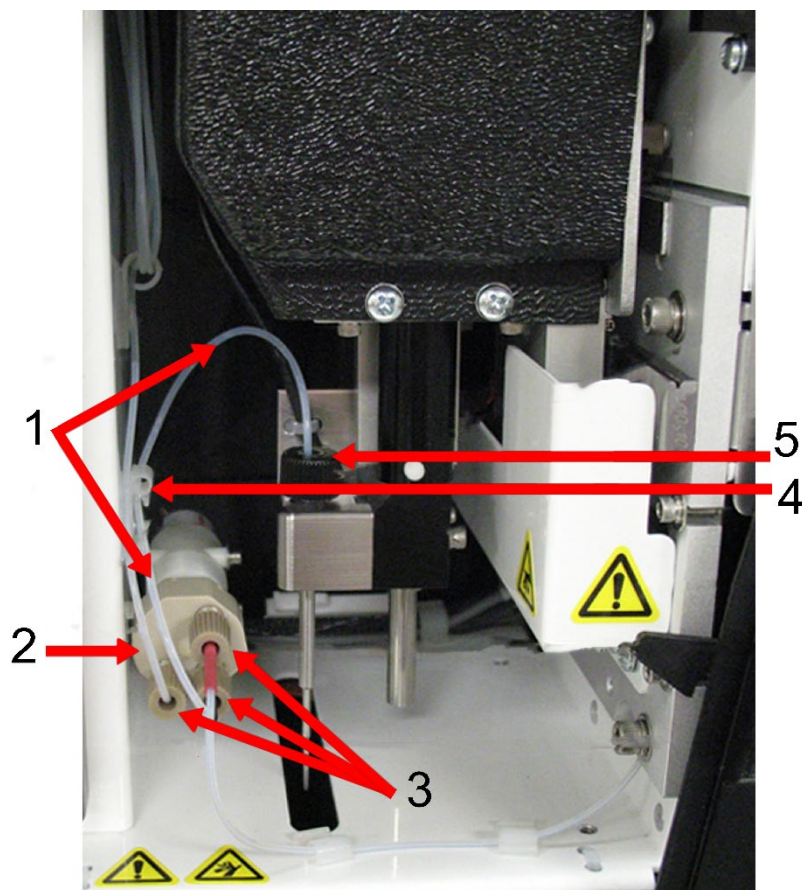

1.	Sample probe tube (color-coded black at valve end)
2.	Valve
3.	1/4-28 flat-bottom fittings
4.	Strain relief
5.	Probe fitting

Figure 16: Sample Probe Tube Assembly

1.	1/4-28 Flat-bottom fitting
2.	Tube between probe and valve
3.	Probe fitting

To replace the sample probe tube:

1. Turn off the MAGPIX® and unplug the power cord.
2. Open the side access door and locate the sample probe assembly.
 - a. Insert the tool in the side access door latch and turn it one quarter turn clockwise. Slide the door to the right.
3. Unscrew the sample probe fitting completely.
4. Unscrew the 1/4-28 flat-bottom fitting at the valve end of the sample probe tube. The sample probe tube is connected to the valve. Use pliers to disconnect the 1/4-28 flat-bottom fitting if necessary.
5. Pull the clip on the strain relief up and pull the tube down and out.
6. Place the new tube in the strain relief by pulling up on the strain relief clip and slide the tubing up and into the strain relief.
7. Screw the 1/4-28 flat-bottom fitting on the end of the new sample probe tube assembly into the valve where you removed the fitting during the step above.
8. Screw the probe fitting on the end of the new sample probe tube assembly into the top of the sample probe assembly where you removed the probe fitting in the step above. Tighten the fitting until the fitting clicks.

As Needed Maintenance

Replace the Fuses

Periodically, you may need to replace a fuse on the MAGPIX®. Use fuses with the following specifications: F2A, 250 V

The fuse cartridge will accept either 5 mm x 20 mm or 0.25 inch x 1.25 inch fuses. Fuses are available from Luminex Corporation. Replacing a fuse requires access to the back of the MAGPIX.



To avoid serious injury or death by electric shock, turn off the system and unplug the power cord from the wall before replacing a fuse

To replace a fuse:

1. Turn off the MAGPIX and unplug the power cord.
2. Use a small, flat blade screwdriver to open the power module door on the lower right corner of the back of the system. The door opens downward, inside is a red cartridge.
3. Use the screwdriver to remove the red cartridge.

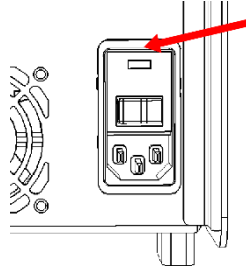

4. Check both of the fuses in the cartridge for damage. A fuse can display physical evidence of damage, for example, broken wire or blackened glass; if the fuse displays no physical evidence, test the fuse for continuity with a volt- meter.
5. Replace any damaged fuse with the correct type of fuse.
6. Replace the red cartridge.
7. Shut the module door.
8. Plug in the power cord and turn on the MAGPIX.

Back up the System

Before uninstalling xPONENT® software, perform a back up of the system. You can also schedule regular backups of the data.



If you need to uninstall, reinstall, or install additional instances of xPONENT®, please contact Luminex Technical Support. Versions of xPONENT are only compatible with specific xMAP® instruments. Use of an incompatible version of xPONENT is not a supported configuration and may lead to calibration or performance verification failure. Before performing any software uninstall or installation steps, contact Luminex Technical Support to ensure that hardware and software versions are fully compatible and supported.

1. Log off and exit out of xPONENT before performing a backup of the system.
2. Navigate to the **Windows logo** > **Luminex** folder > **xPONENT Archive**. The **Archive Utility** dialog box displays.
3. Click **System Backup**.
 - a. In the **Login** dialog box, enter the admin **User name** and **Password** if you have the secure version of the soft- ware. Click **OK**.
 - b. In the **Browse For Folder** dialog box, navigate to the **Backup** folder - which should automatically be chosen. Click **OK**.

NOTE: The System Backup Started dialog box displays at the bottom right of the screen.

4. Click **Close** in the **Archive Utility** dialog box.
5. When the backup is complete, navigate to the desktop and double-click the **Backup** shortcut folder.

You will see the backup zip file and the name includes the date and time.

Archive Data

Set Up Automatic Archiving

1. Navigate to the **Admin** page > **Archive** tab.
2. Click **Launch Archive Utility**. The **Archive Utility** dialog box displays.
3. Click **Edit** under **Schedule Overview**. The **Login** dialog box displays.
 - a. Enter your **User name** and **Password**, if you have the secure version of the software.
 - b. Click **OK**.
4. Specify when you want your archives to begin, using the calendar.
5. Using the drop-down menu, choose the frequency of how often you want to perform archives.
NOTE: The default frequency to archive is daily.
6. Select **Reminder Only** to be reminded of the need to archive, after which you must archive manually. Clear this check box to enable automatic archives.
7. In **To Be Archived**, choose the date and batch parameters for the files you want to archive:
 - Only archive batches older than: [x] Days
 - Always keep the last: [x] Batches
 - Archive all system logs older than: [x] Days
8. In the **Archive Folder** section, verify the location to which you want to archive the file(s). To change the location, click **Browse**, then navigate to the new location and click **OK**.
NOTE: If you change the default archive location, ensure that the Archive Folder section reflects that same location when you import those archived files.
9. Click **Save** to save your settings.

Perform a Manual Archive

Use Manual Archive only when you need to archive specific individual files.

1. Navigate to the **Admin** page > **Archive** tab > click **Launch Archive Utility**. The **Archive Utility** dialog box displays.
2. In the **Archive Utility** dialog box, click **Manual Archive**.
3. In the **Login** dialog box, enter the username and password, and click **OK**.
4. Use the tabs on the left side of the window to choose the type of files you want to archive.
NOTE: Each tab opens a list of files available for archiving, except Logs, which requires only a choice of how old, in days, a file has to be archived.
5. Choose the files you want to archive from the list on the left and use the arrow keys to move those files to the **To Be Archived** box on the right. For log files, select the age of the files, in days.
6. Click **Archive** to move the selected files to the archive.
NOTE: You must archive each group of files separately. If you select a different tab without archiving first, xPONENT® warns you that you will lose the information in the To Be Archived box.

7. Click **Close**.

Maintenance Log

Reproduce the following form as necessary and use them to record maintenance information.

Chapter 10: Storing the System

Store the System

To prepare the MAGPIX® for long-term storage:

1. Navigate to the **Maintenance page > Cmds & Routines** tab.
2. From the **Routine** name drop-down menu, choose the **Prepare for Storage** routine.
3. Click **Run**.
4. Remove the sample probe from the instrument and flush the sample probe with distilled water from the narrow end out through the larger end.
5. Replace the sample probe in the probe holder and wrap the end of the probe with PARAFILM®.
6. Remove the drive fluid bottle and empty the waste fluid bottle.
7. Eject the plate carrier and remove the plate and the off-plate reagent block from the plate carrier.

Prepare the System for Use After Storage

To prepare the system for use after long-term storage:

1. Make sure that the drive fluid bottle has enough drive fluid that the system is not giving you an error, and that the waste fluid bottle is empty.
2. Remove the PARAFILM® from the end of the sample probe.
3. Turn on the MAGPIX® and watch for the following indications of correct response:
 - Air blows out of the fans.
 - The syringe inside the side access door of the MAGPIX initializes.
4. Turn on the PC and start xPONENT®.
5. Navigate to the **Maintenance page > Cmds & Routines** tab.
6. From the **Routine** name drop-down menu, choose **Revive After Storage** routine.
7. Click **Eject**.
8. Add the appropriate reagents to the reservoirs.
9. Click **Retract**.
10. Click **Run**.

Chapter 11: Shipping and Decontaminating the System

If a serious problem arises with the MAGPIX®, you may need to return the system to Luminex Corporation for repairs. If *Luminex Technical Support* directs you to return the system, the Technical Support representative will provide you with all the necessary information as well as a Return Material Authorization (RMA) number.



Before the instrument is returned, perform two procedures: Decontaminate the instrument and prepare the instrument for shipping.

Decontaminate the System

Occasions may arise when it becomes necessary to decontaminate the entire MAGPIX® system. If you must decontaminate the system, sanitize the accessible surfaces and the internal fluidics system. This is particularly important when biohazardous samples have been run.

NOTE: Sodium hypochlorite solutions containing small amounts of sodium chloride (NaCl), sodium carbonate (Na₂CO₃), sodium hydroxide (NaOH), and other pH buffers may be used. Do not use sodium hypochlorite solutions containing film-forming agents, such as Diallyldimethylammonium Chloride (DADMAC), or other additives.

NOTE: The xPONENT® for MAGPIX® software may refer to a 0.6% sodium hypochlorite solution with no additives as '10% to 20% household bleach'.



Wear appropriate personal protective equipment (PPE) when handling parts that come into contact with potentially biohazardous samples.

To decontaminate the MAGPIX system:

1. Remove all specimens and reagents from the system.
2. Leave distilled water and a 0.6% sodium hypochlorite solution with no additives in the off-plate reagent block of the system.
3. Run a **Sanitize** command with a 0.6% sodium hypochlorite solution with no additives, followed by two **Wash** commands with distilled water.
4. Empty the off-plate reagent block and the waste fluid container and clean each with a 0.6% sodium hypochlorite solution with no additives, followed by a distilled water rinse.
5. Turn off the MAGPIX and unplug the power cord.
6. Clean all exterior surfaces with a mild detergent, followed by a 0.6% sodium hypochlorite solution with no additives.

7. Open the side access door of the instrument.
 - a. Insert the tool in the side access door latch and turn it one quarter turn clockwise. Slide the door to the right.
8. Clean all accessible surfaces with a mild detergent, followed by a 0.6% sodium hypochlorite solution with no additives .

Prepare the System for Shipping

1. Disconnect and remove the drive fluid bottle.
2. Remove the off-plate reagent block and any plates.
3. In xPONENT®, perform two **Prime** commands. This should remove fluid from the lines.
4. Empty the waste bottle.
5. Remove the sample probe.
6. Re-insert the red shipping plug, included with the shipping materials provided by Luminex.

Shipment Checklist

Complete the following checklist, sign and date it, and return it with the MAGPIX®.

1. Remove all specimens from the instrument.
2. Decontaminate the instrument.

NOTE: It is the user's responsibility to decontaminate the instrument before shipment.
3. Prepare the instrument for shipping.
4. Was there an internal leak in the system? YES NO

Printed Name:	
Signature:	
Company/Institution	
Date:	
Instrument Serial Number:	

Dispose of the System



Within the European Union, the Waste Electrical and Electronic Equipment Directive requires that you properly dispose of electrical and electronic equipment when it reaches its end of life.

If you are disposing of a MAGPIX® instrument, decontaminate the system. Next, contact *Luminex Technical Support* for a Return Material Authorization (RMA) number at +1-512-381-4397 (outside of the U.S.). Return the equipment to the following Luminex location:

Luminex Corporation

12201 Technology Blvd., Suite 130

Austin, Texas 78727,

USA

For information about disposal of the system outside of the European Union, contact *Luminex Technical Support*. For information about disposal of the barcode scanner, PC, or monitor, refer to the manufacturer documentation.

Appendix A: Software Functionality

Software Packages

Multiple levels of user access can be licensed for xPONENT®. The Basic license key includes:

- **Basic Software** - Allows the end user to perform analysis from protocols and batches, review and print reports, and perform Luminex system maintenance.
- **Instrument Control** - Allows the application to connect to and communicate with an instrument identified by a specific serial number.
- **Remote Web Monitoring** - Allows the end user to view alerts and system status from a different computer using a webpage.

Additional features for which you can obtain a license:

- **Secure** - Includes all of the Basic functions as well as administrator-controlled user permission levels.
- **21 CFR Part 11** - Includes all of the Secure package features as well as the option to require electronic signatures to perform certain tasks. (Electronic signatures are listed in the system log.)
- **Automation** - Includes the ability to communicate with external hardware.
- **LIS** - Enables the system to communicate with an external Laboratory Information System (LIS) database. The LIS package enables you to export and import patient result data in ASTM file format.

For more information about purchasing additional features, or to obtain specific package documentation, contact your vendor.

Home Page

Figure 17: Home Page

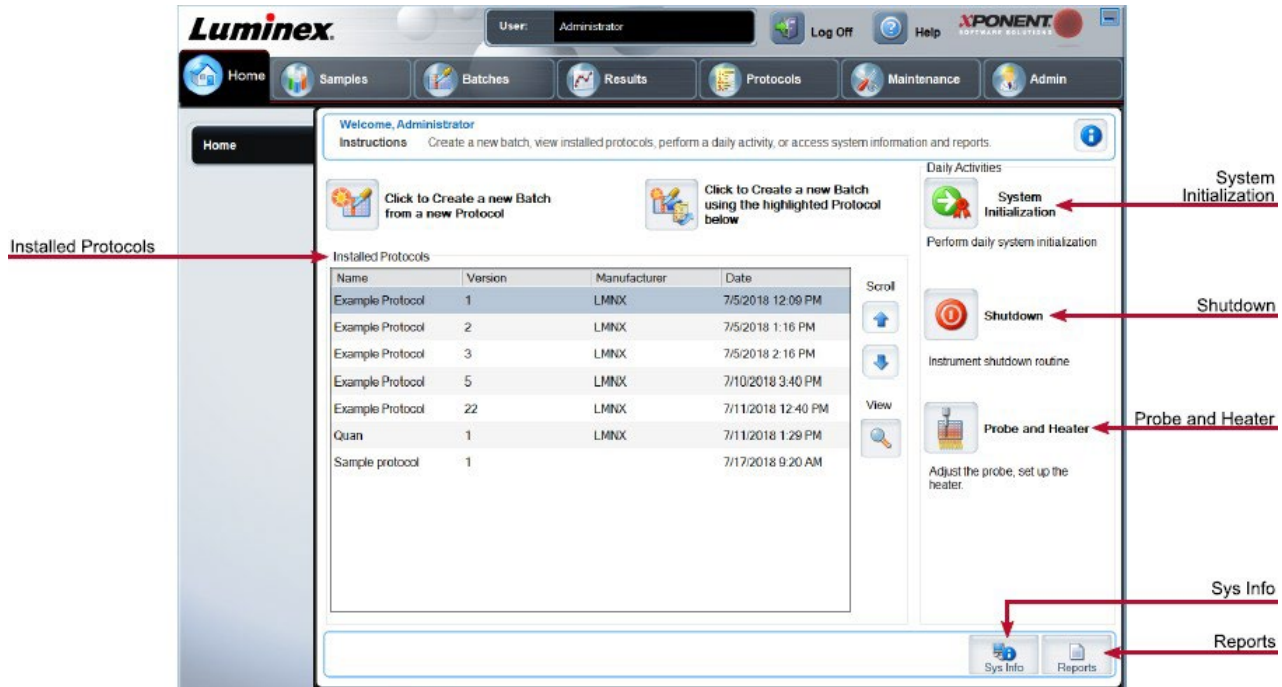

The Home page displays a welcome message, batch creation buttons, Daily Activities shortcuts, and the Installed Protocols list. Return to the Home page at any time by clicking Home in the navigation toolbar.

Table 11. Home Page Screen Elements

Click to Create a new Batch using the highlighted Protocol below	Creates a new batch using a selected protocol from the Installed Protocols list.
Installed Protocols	Displays a list of protocols.
Scroll	Scrolls through the list of protocols.
View	Opens Protocols tab > Settings subtab to view the chosen protocol.
Sys Info	Opens Maintenance page > System Info tab.
Reports	Opens Results page > Reports tab.
System Initialization	Opens Maintenance page > Auto Maint tab.

Certain sections of the software such as tables, lists, and text boxes have right-click option menus. Menus are different depending upon the item you right-clicked.

Table 12. Right-Click Menu Screen Elements

Print All	Prints all sections or cells of the item.
Print Selection	Prints only the selected section or cell.
Import	Imports a file.
Export/Export Grid Contents	Exports all data from the right-clicked item.
Cut	Cuts the selected data.
Copy All	Copies all data.
Copy	Copies only the selected data.
Paste	Pastes previously copied text or data into the field.
Delete	Erases text or data from the selection.

Online Help

English-language help is available at all times while you are using xPONENT®.

To display online help for the page or tab you are currently working in, click the “i” icon, in the upper-right corner of the xPONENT window. A help window displays information specific to that page or tab.

To display system-level help, click the “?” at the top of the xPONENT window, then click Contents and Index. A help window displays so you can navigate to any available topic.

To display quick start information, click the “?” at the top of the xPONENT window, then click Quick Start. A help window displays information about the basic steps to start the system.

To display software information, click the “?” at the top of the xPONENT window, then click About Luminex® xPONENT. The xPONENT information dialog box displays the software version information.

System Monitor Overview

The System Monitor is located at the bottom of all xPONENT® windows. The System Monitor displays the physical state of the Luminex® system. Values are reported directly from the Luminex system.

System Status button	When clicked, the System Log displays. It also displays the current status of the system. If there are no warnings or errors, the System Status button is green with a check mark. If there is a warning, out of calibration condition, or other important user notification, the button is yellow with an exclamation point.
Connected Status	Displays the status of the instrument's connection to the PC (Connected or Disconnected).
Check Cal/Ver Status	Displays a white X if there is a failed calibration or verification.
Command display	Displays the command currently running, the system state (i.e., running, idle, etc.), and date and time.
Progress bar	Displays a bar graph showing the progress of the current command or routine; if the command or routine is finished, it displays a full progress bar and the command status as Complete .
Stop button	Stops the system, regardless of command status. Use this only if it does not matter whether the data from the current well is lost.
Pause button	Pauses the system after the current command completes. Pause does not stop the system in the middle of running a command. You cannot run another command while the system is paused. Pause the system before stopping it so that it will finish the current command and store the pending batch and then resume exactly where it left off.
Eject button	Ejects the plate. Once the plate is ejected, the Eject button changes to Retract . Retract retracts the plate, and the Retract button changes back to Eject .
Drive Fluid Level	The drive fluid liquid level sensor warns you when the drive fluid is low. There can be enough drive fluid left in the bottle to finish a plate. The system does NOT stop until an air bubble is detected in the line coming from the drive fluid bottle.
Waste Fluid Level	The waste fluid bottle liquid level sensor stops the current plate if the waste bottle is full.
Delta Cal Temp	Displays the difference in temperature between the current reading and the reading when the system was calibrated, in degrees Celsius.
XY Status	Displays the current location of the command, and the temperature of the plate heating block in degrees Celsius.
Power Off button	Powers off the instrument.

Arrange Main Navigation Pages

NOTE: The Home page cannot be moved. The Admin page cannot be removed if a security license is not being used, or if the user currently logged in is set up as a member of the Administrator group profile.

To arrange the main navigation buttons:

1. Navigate to the **Admin** page > **System Setup** tab.
2. In the **Arrange Main Navigation Button** section, select or clear the check boxes by each page name to hide or display the page.
3. Click a main page header and then click the up and down arrows to change the order in which the pages display, from left to right.
4. Click **Save**.
5. Click **Default** if you want to restore the main navigation.
6. In the **Settings Saved** dialog box, click **OK**.

Samples Page

Samples Tab

Use the Samples tab to create new samples, view the sample list, create a batch, and to view and edit samples for protocols. The Samples tab is intended to be used with an Laboratory Information System (LIS). If you want to import a sample list, use the Import List function when creating the batch or editing the protocol.

Figure 18: Samples Tab

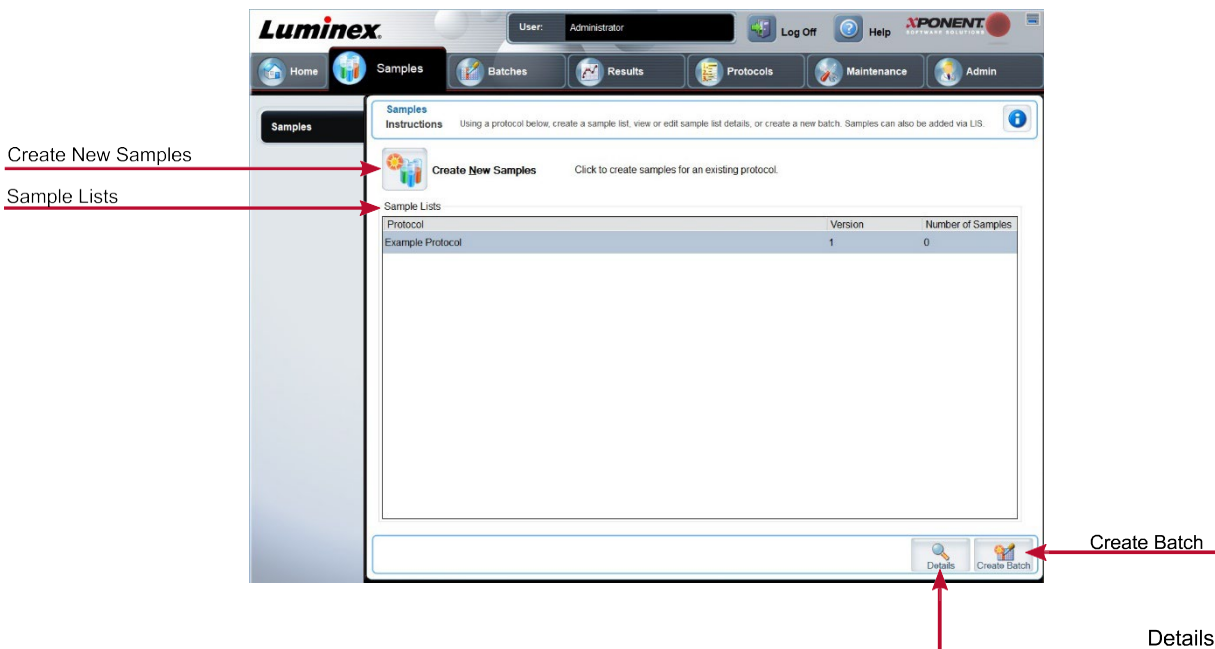

Table 13. Samples Tab Screen Elements

Create New Samples	Creates a new sample.
Details	View and edit sample details for the chosen protocol.
Create Batch	Creates a LIS batch for the protocol.

Create Sample Subtab

Use the Create Sample subtab to enter and view sample information.

Click Create New Samples from the Samples tab to display the Create Sample subtab. In the Sample section, if you have the Laboratory Information System (LIS)-enabled version of the software and are currently connected to the LIS, the sample list auto-populates when the LIS provides sample orders. You can only view or run a sample list created in the LIS; you cannot edit it.

Edit Samples Subtab

Use the Edit Samples subtab to edit a sample for the chosen protocol.

Batches Page

Batches Tab

Use the Batches tab to create a new batch from an existing protocol, and create a new multi-batch.

Figure 19: Batches Tab

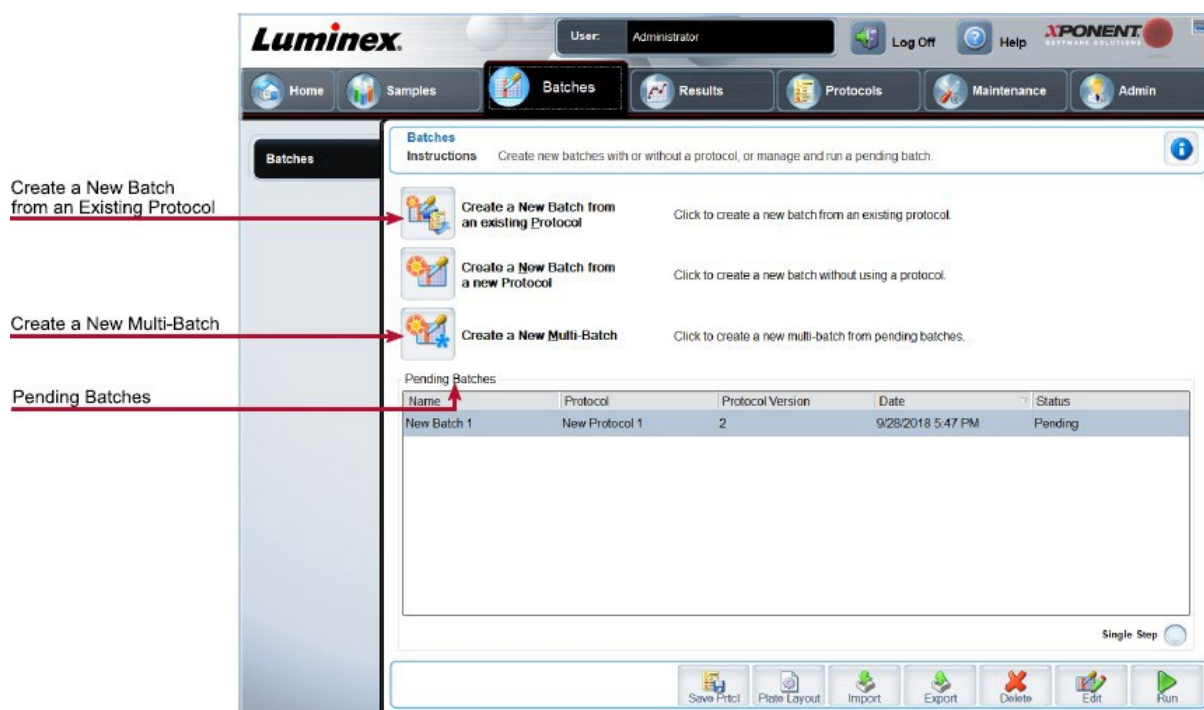

Table 14. Batches Tab Screen Elements

Create a New Batch from an existing Protocol	Creates a new batch from an existing protocol.
Create a New Multi-Batch	Creates a new multi-batch.
Pending batches	Displays the name of the protocol used with the batch, the protocol version, date, and status for each pending batch.
Single Step	Instructs the system to acquire one well and then pause. If Single Step is activated during a batch, the batch pauses at the end of the current well. This ensures that the system is working currently before you run an entire batch.

Save Prtcl	Saves protocol and/or assay information for a standard/control.
Plate Layout	Opens the Report dialog box, which includes the Batch Plate Layout Report. Confirm that the plate layout conforms to your specific assay instructions.
Import	Imports a batch, not previously run in xPONENT®, from a folder on the PC.
Export	Exports the batch information in order to move it to another computer, make a copy of the data, and then import it into xPONENT on another computer.

Batches Tab > Protocol Subtab

Use the Protocol subtab to name a batch, enter a batch description, choose the protocol needed for running the batch, and view active reagents.

Figure 20: Protocol Subtab

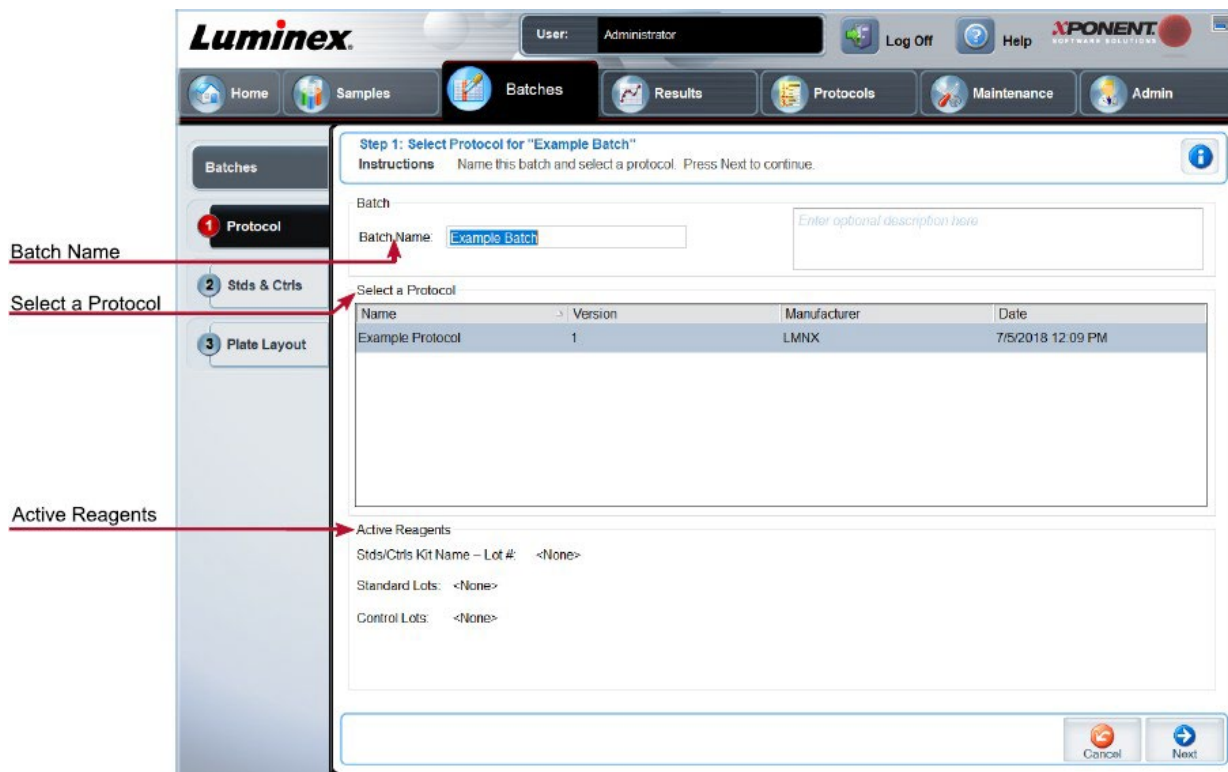

Table 15. Protocol Subtab Screen Elements

Batch Name/Description	Batch name and batch description.
Select a Protocol	Contains the protocol name, version, manufacturer, and creation date for each protocol

<p>Active Reagents</p>	<p>Displays assay and control lots/kits associated with the selected protocol. The Stds/Ctrls Kit Name - Lot# field displays the assay standard/control kit/lot name and lot number currently associated with the selected protocol.</p>
-------------------------------	--

Batches Tab > Stds & Ctrls (Standards and Controls) Subtab

Use the Stds & Ctrls subtab to apply a kit or lot.

Figure 21: Stds & Ctrls Subtab

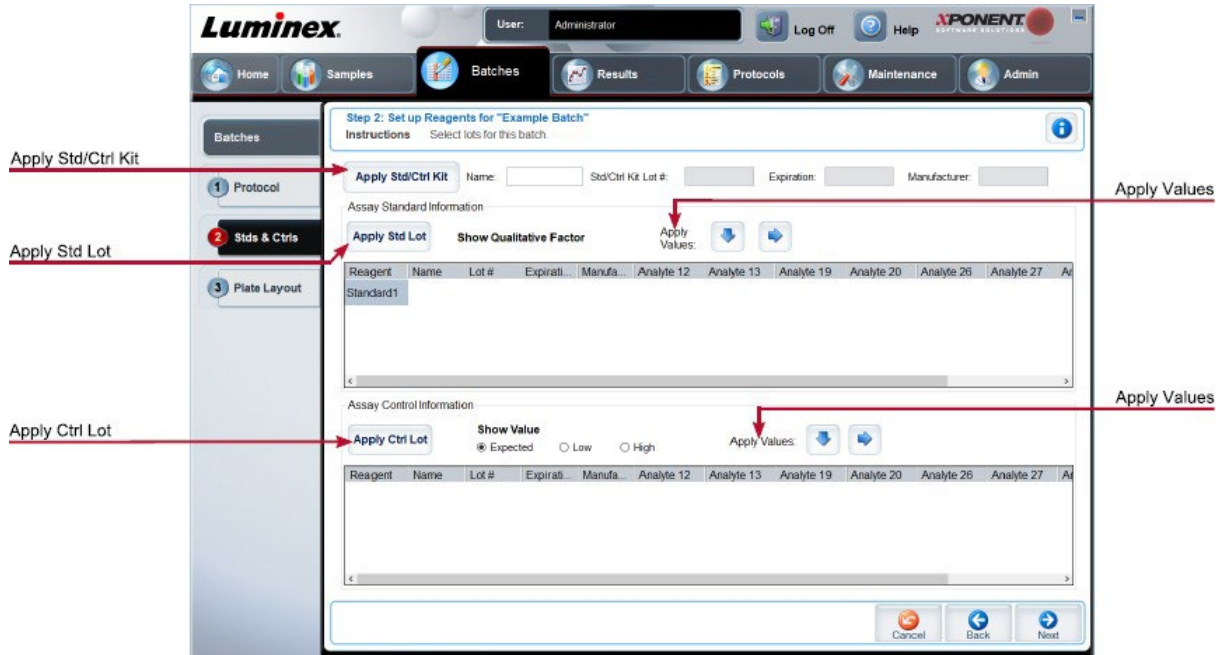

Table 16. Stds & Ctrls Subtab Screen Elements

<p>Apply Std/Ctrl Kit</p>	<p>Applies a Std/Ctrl Kit. The chosen kit must be associated with the same analyte names.</p>
<p>Assay Standard Information</p>	<p>Displays the chosen standard reagents in a list. Click the Reagent column header to re-sort the order from the highest number standard to standard number one. This is useful for applying dilutions in which the last standard is the highest standard.</p> <p>Apply Std Lot - Applies a standard lot.</p> <p>Apply Values arrow buttons - Applies a value down or across the list of analytes.</p>
<p>Assay Control Information</p>	<p>Lists the selected control reagents. Existing control lot information can be applied or new information can be entered manually.</p>

	<p>Apply Ctrl Lot - Applies a control lot.</p> <p>Show Value - Expected, Low, and High set the expected, lowest, or highest acceptable concentration of the analyte in the sample.</p> <p>Apply Values arrow buttons - Applies a value down or across the list of analytes.</p>
Dilution	<ul style="list-style-type: none">• 1:2 - Halves the standard from each previous iteration.• 1:10 (Log) - Computes a value of one-tenth of the standard from each previous iteration.• 1/2 Log - Creates a 1:3.16 dilution, or half of each 1:10 (Log) from each previous iteration.
Apply Dilution	<p>Applies the dilution selected in the Dilution list.</p> <p>NOTE: The Dilution list and Apply Dilution button are displayed only if a quantitative analysis has been selected.</p> <p>NOTE: You can also manually type a number to set your own dilution factor. It must be a whole number.</p>

Batches Tab > Plate Layout Subtab

Use the Plate Layout subtab to define commands that apply to one or more wells, define off-plate and maintenance commands, and define well locations for samples, standards, controls, and background.

Figure 22: Plate Layout Subtab

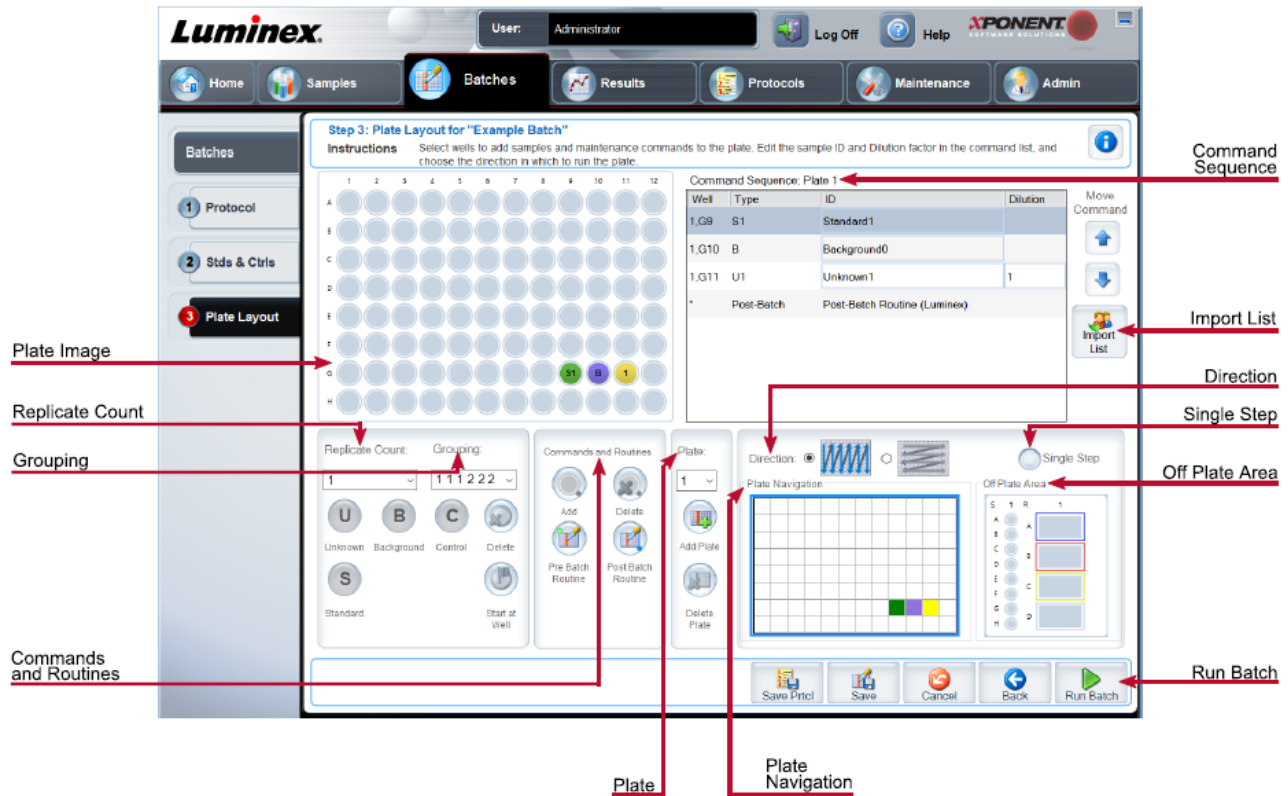

Table 17. Plate Layout Subtab Screen Elements

Plate Image	Represents the plate. Each well appears as a circle on the grid. Well commands appear in the appropriate circles as you assign them to wells on the plate.
Command Sequence	Contains the command sequence for the active plate. A command's ID and Dilution fields have a blue border around them if they can be double-clicked to enter information.
Move Command	Changes the acquisition order of a command.
Replicate Count	Defines a quantity of replicate sets from one to nine. Replicate count selection must be made before adding a well command

Grouping	<p>Selects the sequence in which the replicates are laid out in plate wells. Options for Grouping are:</p> <ul style="list-style-type: none"> • 123123123. . . Lays out one of each replicate set at a time in numerical order. • 111222333. . . Lays out all the replicates in a set before moving on to the next set in numerical order. <p>Each command is associated with a color. Click and drag to highlight a series of wells; click a column or row header to highlight the entire column or row, or click and highlight different wells and then click a command below to assign that command to all the highlighted wells.</p> <ul style="list-style-type: none"> • Unknown (U): Yellow • Background (B): Purple • Control (C): Red • Standard (S): Green
	Delete - Removes the well command from the selected well.
	Start at Well - Enables you to begin acquisition at a well other than A1.
Commands and Routines	<p>Allows you to add and delete commands and routines, and to create pre and post batch routines. If you select a routine you created, that routine must also exist on any system to which you import this protocol. The system displays an error when attempting to run a batch on a system where the routine does not exist.</p> <p>Wells and commands you assign to the protocol plate layout are saved into the protocol settings and execute each time you use the protocol to run a batch. Standards and controls associated with a given protocol typically remain constant, while the number of unknown wells often varies. You can assign a specific number of unknown wells to the plate when setting up a batch.</p> <p>Before adding well commands, delete all standards from the plate layout if any of the standards need to be rearranged. Delete all controls from the plate layout if any of the controls need to be rearranged.</p>
	Add - Adds a command or routine to the selected well.
	Delete - Deletes any command or routine associated with the selected well.
	Pre-Batch Routine - Adds the command or routine before running the batch.
	Post-Batch Routine - Adds the command or routine for running the batch.
Plate	Specifies the plate to display in the plate image in the list.
	Add Plate – Adds a new plate to the batch
	Delete Plate – Deletes the plate highlighted in the list.

Direction	Specifies the direction to run the plate commands. The selected direction also dictates how wells are added to the plate when assigning multiple unknowns, standards, and controls at one time.
Plate Navigation	Displays a smaller plate image for the current batch.
Single Step	Instructs the system to acquire one well and then pause. If Single Step is activated during a batch, the batch pauses at the end of the current well. This ensures that the system is working currently before you run an entire batch.
Off Plate Area	Displays the location for maintenance commands in the Command Sequence list.
Save Prtcl (When creating a batch)	Opens the Save Protocol dialog box to save the protocol and/or kit.
Run Batch	Runs the batch and opens the Current Batch tab, where you can monitor the batch as it runs.
Import List	Imports a sample list into the Command Sequence section.

Batches Tab > Settings Subtab

Use the Settings subtab to name your new batch and configure acquisition settings, view the acquisition parameters of the selected saved batch (for existing batches), and print the batch settings report.

NOTE: When running a kit with a provided protocol, the protocol for the assay must be run as instructed in the assay's package insert.

Table 18. Settings Subtab Screen Elements

Volume	The instrument acquires from the sample well the desired sample volume (µL). Use values ranging from 20 µL to 200 µL. To avoid air intake, add an additional 25 µL to the sample volume in each well. The default value is 50 µL.
XY Heater	Select Enabled to enable the XY heater. In the field, type the desired value in degrees C . The temperature range is 35°C to 60°C in 0.5 increments.
	Acquiring data before the heater has reached the proper temperature can compromise test results.
Analysis Type	Use this list to choose from the following analysis types: None - No analysis. Choose if you have your own data post-processing program and want to obtain only fluorescent intensity results. You cannot apply standards or controls when you select None. You cannot analyze acquisitions with this setting.

	<p>Qualitative - Qualitative analysis determines results as either positive or negative, reactive or non-reactive. The software is flexible in defining custom result ranges, such as negative, low positive, or high positive. Determinations are based on a single standard. For qualitative analysis the Luminex software uses a specific algorithm, shown below.</p> $(FI_{\text{sample}})/(FI_{\text{standard}}) = Ki$ <p>Where FI = Fluorescent Intensity and Ki = a “Quali” value entered in lot information to determine the value or the qualitative assay standard.</p> <p>The “Quali” value determines a cutoff or threshold. This, in conjunction with ranges using the Lum Quali formula or an edited range specific for your assay, helps to determine qualitative results for unknown samples.</p> <p>Two predefined formulas using the algorithm are included in the system. You can use them as is or edit their range values to meet your requirements</p> <p>Quantitative - Determines the sample concentrations from standard curves using regression methods. Cubic Spline, Linear, Logistic 4P, and Logistic 5P. Enter the desired values for standards and controls in the Number of Standards and Number of Controls fields. Select either Fit of All Standards or Mean of Replicates for the calculation of the curve fit.</p> <p>Luminex recommends Fit of All Standards as the most accurate calculation of the curve fit.</p> <p>Based on a range of quantitative, numerical results, a threshold range can be applied to a quantitative analysis, for example, high, low, saturated, and expected.</p>
Number of Standards	The number of standards for the protocol. Applies only to qualitative and quantitative analysis.
Number of Controls	The number of controls for the protocol. Applies only to qualitative and quantitative analysis.
Fit of all Standards	Determines the standard curve by using each individual standard replicate when calculating the standard curve. For example, if you run duplicates of a 7-point standard curve, the software will calculate the standard curve by using 14 points. Applies only to quantitative analysis.
Mean of Replicates	Averages the individual standard replicates when calculating the standard curve. Applies only to quantitative analysis. For example, if you run duplicates of a 7-point standard curve, the software will calculate the standard curve by using 7-averaged points.
Analyze results while acquiring samples	The software allows real-time viewing of the results as the instrument analyzes samples. This feature is not available if you chose None as your analysis type.
Use External Analysis Program	Use a third-party program to analyze the data. The Analysis Program list becomes active. Applies only to qualitative and quantitative analysis.

Batches Tab > Analytes Subtab

Use the Analytes subtab to select or edit analytes used in the batch or protocol.

Figure 23: Analytes Subtab

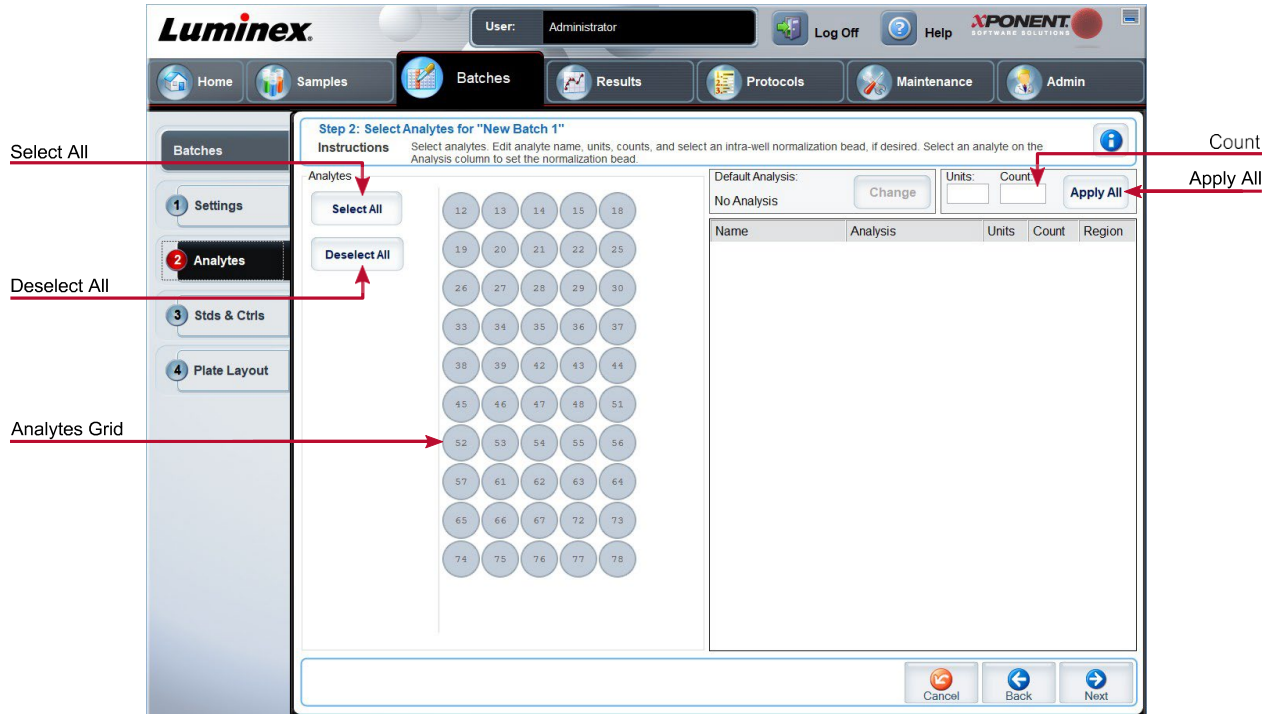

Table 19. Analytes Subtab Screen Elements

Analytes grid	A grid representing each analyte from 12 to 78.
	Select All – Selects all analytes.
	Deselect All – Deselects all analytes.
Count	The desired bead count for the analytes. The instrument will analyze the sample until it has analyzed the count chosen for each bead region or until the timeout is reached if that feature was enabled.
Units	Enter the desired units for the analytes in this field.
Apply All	Applies the information in the Units and Counts fields to all analytes.

Setting Up Batches

Batches consist of protocols and samples for acquisition and can span more than one plate. Protocols contain predefined commands that must be included in every batch acquisition. You can group batches together as a multi-batch. Multi-batches can consist of any number of batches that have been set up from different protocols and are processed consecutively. Multi-batches cannot be run on multiple plates.

When setting up a batch, if the number of samples exceeds the number of wells in one plate, you can add additional plates in the Add and Change Plate section. Additional plates are identified on the bottom of the plate image as Plate a of b, where a is the plate number and b is the total number of plates.

NOTE: Luminex recommends that the manufacturer assay kit controls are analyzed with each plate.

Assay kit manufacturers may provide protocols in their kits which are distributed on media. Protocols typically include assay values for standards and controls, and maintenance commands (such as washes or primes to acquire along with samples). Assay reagents are included in assay kits. You must provide information about these reagents, such as lot numbers and concentration values for the standards and assay controls.

New Multi-Batch Subtab

Use the Create New Multi-Batch button to add or remove batches to the multi-batch set up and to run a multi-batch.

A multi-batch is a set of batches that you want to process consecutively. Add batches to the multi-batch from pending batches in your database. You can also create a new batch to add to the database for the multi-batch. Include as many batches as you need, up to 96 batches. This feature enables you to conserve plates.

Ensure that batches fit on one plate. If space limitations create an overlap, an error message displays. Results for each batch are saved as individual batch files.

Table 20. New Multi-Batch Subtab Screen Elements

Select Pending Batch	Contains a list of all pending batches. Select the batch you want to add to the plate.
Multi-Batch	Lists pending batches selected for the multi-batch. The list includes name and “Start at” well.
Plate Layout	Opens the Multi-batch Report dialog box.
Multi-Batch Plate Layout Report	Includes the multi-batch plate layout, command number, plate location, command type, sample ID and dilution. The report is date and time stamped.
New Batch	Creates your new batch.
Add	Adds a batch from available options. The selected batch then appears on the plate layout. After you add each batch, the software automatically adds the next batch to the first well of the next column or row (depending on the plate direction). You can also select a well first, which places the next batch in your chosen location.
Remove	Removes a selected batch in the Multi-Batch list. The batch still remains in the Pending Batches section. This button is displayed only if you have added a batch to the Multi-Batch list and selected the batch from the list.

Results Page

Once a batch has begun running, observation and analysis take place in the Results page. This page contains the following tabs and subtabs:

- **Current Batch** tab - View statistics for the current run and analyte progress per well.
- **Saved Batches** tab - View information about already processed batches and, if necessary, replay them or recalculate their data.
- Click **Replay > Recalculate Data** from the **Saved Batches** tab.
- Click **Replay > Replay Batch** from the **Saved Batches** tab.
- **LIS Results** tab - View a batch or transmit a batch that contains Laboratory Information System (LIS) results.
- **Reports** tab - This tab enables you to select a report to view.

Performing Analysis

If you are using a third-party software to perform analysis, see the user manual provided with that software. Follow the assay's package insert when running a kit with data analysis instructions.

NOTE: Luminex recommends using median statistics for data analysis.

You can direct the system to acquire samples in replicate regardless of batch type. For qualitative batches, qualitative results for replicates are averaged, and the reported interpretation is determined from this replicate average.

Replicates in quantitative batches are based on a standard curve that is generated by either the "Fit of all standards" or "Mean of replicates." The default is "Fit of all standards." Unknown samples are calculated from the standard curve. Test results for replicate samples are averaged to determine the reported quantitative result denoted as "AVG."

You can analyze a batch using the analysis features of Qualitative and Quantitative or None.

Current Batch Tab

Use the Current Batch tab to view results, statistics, and log information related to the current batch, and to perform statistical analysis on batch results. This tab offers real-time monitoring of batch sampling during acquisition through a display of sample bead statistics and analytes, and dot plot data. The statistics available on this tab are individual well bead statistics. They do not describe replicate well assay results.

There are four maximize buttons in this window, one for each major pane. Click the appropriate button to maximize the pane. Click the minimize button at the top right of the pane to return to its standard size.

Figure 24: Current Batch Tab

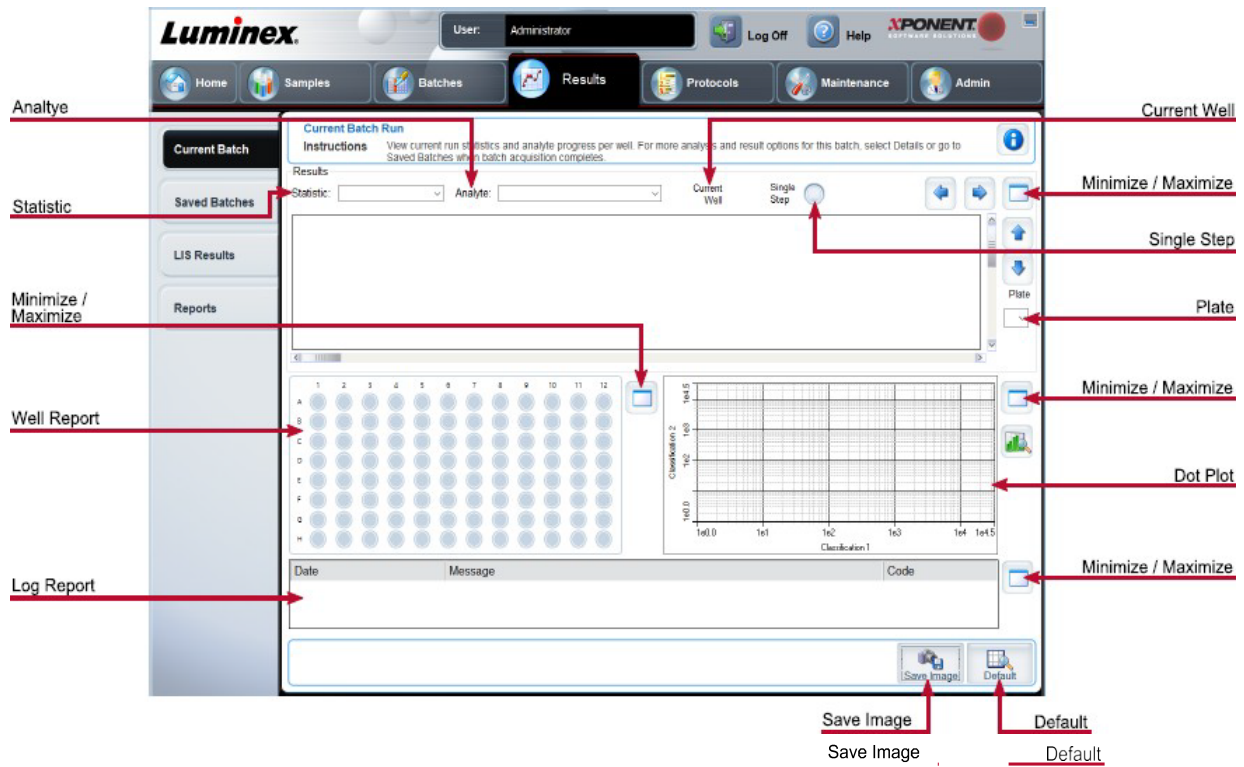

Table 21. Current Batch Tab Screen Elements

<p>Statistic</p>	<p>To view a particular statistic for analytes in a batch, choose one of the options on the drop-down menu. The statistical options displayed change according to the type of analysis.</p> <p>NOTE: Trimmed statistics remove the lower and upper 5% of the extreme statistic values, then use the remaining values for the Mean, Standard Deviation, or %CV calculations. Trimmed statistics remove outliers, ensuring that the data is more representative of the population.</p> <p>Median Fluorescence Intensity (MFI) - The value (detected signal) that is in the middle of the microsphere population when sorted by reporter value, lowest to highest. The median value is much less sensitive than the mean value, due to outliers and carryover.</p> <p>Test Result - The calculated analysis value for quantitative or qualitative assays derived from standards with known values.</p> <p>Range - A semi-quantitative result for a particular numerical result falling between a predefined set of values such as Normal or Negative.</p> <p>Net MFI (Sample Well MFI - Background Well MFI) - The Net MFI can be used to eliminate the effect of background signal in an assay.</p> <p>Count - The number of microspheres detected within the specified microsphere region. Microspheres that are not inside the region on the dot plot are not included.</p> <p>Mean - Average of all values for the microspheres detected in a region.</p>
-------------------------	---

Trimmed Mean - (Optional) The sum of the data points in the trimmed distribution divided by the number of data points.

$$\text{Trimmed Mean} = \Sigma xi / Nt$$

% CV of microspheres - The measure of relative dispersion within the distribution.

$$\% \text{ CV} = 100 \times \text{Std Dev} / \text{Mean}$$

Standard Deviation - For calculating sample variability or dispersion, Luminex uses the standard deviation formula.

Peak - The value that is equal to the largest number of data points within the distribution. For example, in data set {1,2,2,3,3,3,4,5}, 3 is the peak because it occurs the most frequently in the distribution list.

% CV of Replicates - The measure of relative dispersion within the distribution of results for replicate samples.

$$\% \text{ CV} = 100 \times \text{Std Dev} / \text{Mean}$$

% Recovery - A measure of how accurately your observed results match your expected results following regression analysis.

$$(\text{Observed concentration}) / (\text{Expected concentration}) \times 100\%$$

Expected Result - The known or expected test result value for a standard or control.

Control Range - Low - The lowest value for an assay control used to determine pass/fail criteria for an assay.

Control Range - High - The highest value for an assay control used to determine pass/fail criteria for an assay.

Normalized Net - Median - For each analyte in a well, the Normalized Net Median (NNM) = (net median of analyte) / (net median of normalization bead)

Units - The unit of measure for an analyte, for example, pg/mL.

Trimmed Count - (Optional) The number of data points in the trimmed distribution (Nt).

Trimmed % CV of microspheres

Trimmed Standard Deviation - (Optional) The measure of dispersion within the trimmed distribution.

$$\text{Trimmed Std Dev} = ((Nt \Sigma xi^2 - \Sigma xi)^2 / Nt (Nt - 1))^{1/2}$$

Trimmed Peak - (Optional) The value that is equal to the largest number of data points within the trimmed distribution.

Analyte	Contains a list of analytes run in the batch. Select an analyte to view all statistics for that analyte.
Well(s) to View	<p>Current Well - Displays the statistics of the well currently being displayed. (This changes to Displayed Well if viewing a batch using the Open button of the Saved Batches tab.)</p> <p>Single Step - Instructs the system to acquire one well and then pause. If Single Step is activated during a batch, the batch pauses at the end of the current well. This ensures that the system is working correctly before you run an entire batch.</p>
Results	Displays statistics related to the batch. Use the up, down, left, and right arrow buttons to move through the table, or use the scroll bars. The Results will only display when a batch is actively running or when a batch is replayed and not recalculated.
Plate	Select the plate you want to view, if there is more than one plate.
	If using multiple plates, ensure that plates are used in the proper order. Failure to do so can result in inaccurate data and test results.
Well Report	<p>This pane displays a representation of the plate and the status of acquired wells on the left side of the page. Each well displays one of three possible states:</p> <ul style="list-style-type: none"> • Yellow - Well acquired, but the system detects a possible problem. • Green - Well acquired successfully. • Red - Well acquisition unsuccessful; the system might have stopped, depending on the circumstances.
Dot Plot	The default location of the dot plot is the lower-right section of the Current Batch tab. The dot plot is a graphical display of real-time data collection. When using 1 to 50 beads, the dot plot default display shows Classification 1 (CL1) and Classification 2 (CL2).
Log	<p>This pane displays a log of system processes at the bottom of the Current Batch page. Log entries indicating warnings are highlighted in yellow; errors are highlighted in red. Other log entries are not highlighted. The log includes the following information:</p> <ul style="list-style-type: none"> • Date • Message • Code
Progress	Click to display real-time progress of the well acquisition. Analyte counts are displayed in a dynamic bar graph as they are acquired. The scroll bar at the bottom of the Progress display scrolls through the analyte list. A zoom feature on the left of the display enables you to enlarge the image.
Save Image	Opens a Save As dialog box to save a screen capture.
Default	Appears only when the progress display is active. Click to return to the dot plot display.

Saved Batches Tab

Use the Saved Batches tab to open a completed batch, view completed batch details, import, export, or approve a batch, and replay or reacquire a batch.

On the Saved Batches tab click Open to display the following subtabs on the left side of the page: Results, Settings, Log, and Sample Details.

Figure 25: Saved Batches Tab

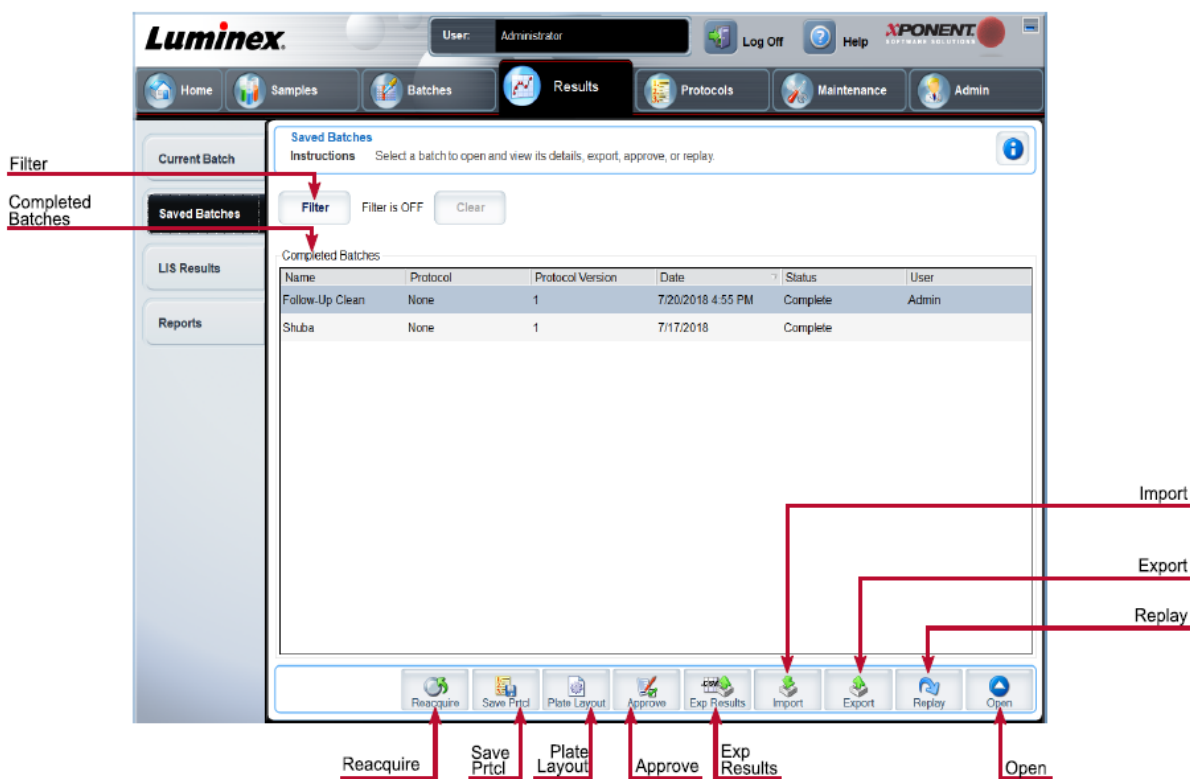

Table 22. Saved Batches Tab Screen Elements

Filter	Displays the saved batches you want to display in the Completed Batches list.
Clear	Turns off the filter.
Completed Batches	Displays a list of completed batches.
Reacquire	Reacquires the selected batch.
Save Prtcl	Opens the Save Protocol dialog box, displaying the kit information for the selected batch.
Plate Layout	Displays the Batch Plate Layout Report.
Approve	Approves the batch.

Exp Results	Choose an export destination for the .csv file containing your results.
Import	Imports a batch file (.mdf). Select Include Raw Files (LXB) to include raw files in the import.
Export	Exports a file. Select Include Raw Files (LXB) to include raw files in the export.
Replay	Enables you to use the data stored in the run files from the initial acquisition to reprocess a batch, creating a new batch output file.
Open	Displays the saved batch results for the selected batch.

Saved Batches Tab > Results Subtab

Table 23. Results Subtab Screen Elements

Statistic	To view a particular statistic for analytes in a batch, select one of the options on the drop-down menu. The statistical options displayed change according to the type of analysis. NOTE: Trimmed statistics (indicated by *) remove the lower and upper five percent of the extreme statistic values, then use the remaining values for the Mean, Standard Deviation, or %CV calculations. The point of a trimmed statistic is that it removes outliers, ensuring that the data is more representative of the population.
	Median Fluorescence Intensity (MFI) - The value (detected signal) that is in the middle of the microsphere population when sorted by reporter value, lowest to highest. The median value is much less sensitive than the mean value, due to outliers and carryover.
	Test Result - The calculated analysis value for quantitative or qualitative assays derived from standards with known values.
	Range - A semi-quantitative result for a particular numerical result falling between a predefined set of values such as Normal or Negative.
	Net MFI (Sample Well MFI - Background Well MFI) - The Net MFI can be used to eliminate the effect of background signal in an assay.
	Count - The number of microspheres detected within the specified microsphere region. Microspheres that are not inside the region on the dot plot are not included.
	Mean - Average of all values for the microspheres detected in a region.
	Trimmed Mean - (Optional) The sum of the data points in the trimmed distribution divided by the number of data points. Trimmed Mean = $\sum xi / Nt$
	% CV of microspheres - The measure of relative dispersion within the distribution. % CV = $100 \times \text{Std Dev} / \text{Mean}$

	<p>Standard Deviation - For calculating sample variability or dispersion, Luminex uses the standard deviation formula.</p>
	<p>Peak - The value that is equal to the largest number of data points within the distribution. For example, in data set {1,2,2,3,3,3,4,5}, 3 is the peak because it occurs the most frequently in the distribution list.</p>
	<p>% CV of Replicates - The measure of relative dispersion within the distribution of results for replicate samples.</p> <p>$\% CV = 100 \times \text{Std Dev} / \text{Mean}$</p>
	<p>% Recovery - A measure of how accurately your observed results match your expected results following regression analysis.</p> <p>$(\text{Observed concentration}) / (\text{Expected concentration}) \times 100\%$</p>
	<p>Expected Result - The known or expected test result value for a standard or control.</p>
	<p>Control Range - Low - The lowest value for an assay control used to determine pass/fail criteria for an assay.</p>
	<p>Control Range - High - The highest value for an assay control used to determine pass/fail criteria for an assay.</p>
	<p>Normalized Net - Median - For each analyte in a well, the Normalized Net Median (NNM) = (net median of analyte) / (net median of normalization bead)</p>
	<p>Units - The unit of measure for an analyte, for example, pg/mL.</p>
	<p>Trimmed Count - (Optional) The number of data points in the trimmed distribution (Nt).</p>
	<p>Trimmed%CV of microspheres</p>
	<p>Trimmed Standard Deviation - (Optional) The measure of dispersion within the trimmed distribution.</p> <p>$\text{Trimmed Std Dev} = ((Nt \sum xi^2 - \sum xi)^2 / Nt (Nt - 1))^{1/2}$</p>
	<p>Trimmed Peak - (Optional) The value that is equal to the largest number of data points within the trimmed distribution.</p>
Analyte	Contains a list of analytes run in the batch. Select an analyte to view all statistics for that analyte.
Displayed Well	Displays the number of the well whose contents currently appear in the table.
Results pane	Displays statistics related to the batch.

Save Image	Saves a screen capture.
Plate	<p>Select the plate you want to view, if there is more than one plate.</p>  <p>If using multiple plates, ensure that plates are used in the proper order. Failure to do so can result in inaccurate data and test results.</p>
Well Report	<p>This pane displays a representation of the plate and the status of acquired wells on the left side of the page. Each well displays one of three possible states:</p> <ul style="list-style-type: none"> • Yellow - Well acquired, but the system detects a possible problem • Green - Well acquired successfully • Red - Well acquisition unsuccessful; the system might have stopped, depending on the circumstances
Dot Plot	The default location of the dot plot is the lower-right section of the Current Batch tab. The dot plot is a graphical display of real-time data collection. When using 1 to 50 beads, the dot plot default display shows Classification 1 (CL1) and Classification 2 (CL2).
Log	<p>This pane displays a log of system processes at the bottom of the Current Batch page. Log entries indicating warnings are highlighted in yellow; errors are highlighted in red. Other log entries are not highlighted. The log includes the following information:</p> <ul style="list-style-type: none"> • Date • Message • Code
Progress	Click to display real-time progress of the well acquisition. Analyte counts are displayed in a dynamic bar graph as they are acquired. The scroll bar at the bottom of the Progress display scrolls through the analyte list. A zoom feature on the left of the display enables you to enlarge the image.
Formula	Opens the Change Analysis dialog box with a list of analytes used in the batch. Click an analyte to open the Analysis Settings dialog box from which you can select a new analysis setting for the analyte.
Default	Returns view to Results page.
Approve	Opens the Batch Approval Confirmation dialog box to approve the batch.
Validate	Validates an entire selected row or cell in the Results table.
Invalidate	Invalidates an entire selected row or cell in the Results table.

Saved Batches Tab > Settings Subtab

When you click the Settings subtab, a report generates displaying the following:

- A date and time stamp at the top of the report
- Left and right Page arrow buttons so that you can view pages in the report
- Calibration State
- Machine Information
- Assay Lots Used
- Tests
- Protocol Settings

Saved Batches Tab > Log Subtab

The Log subtab displays a log of the activity which occurred during the acquisition of the selected batch. The following information is displayed about each activity:

- **Date** - date and time well was acquired
- **Message** - log message about the well
- **Code** - command and error codes

Log entries display yellow if a well was acquired but there was a possible problem, and red if acquisition failed.

- **Print** - Prints the log
- **Export** - Opens the Save As dialog box to save the batch log file. Select a location and click Save
- **Close** - Reopens the Saved Batches tab

Saved Batches Tab > Sample Details Subtab

Table 24. Sample Details Subtab Screen Elements

< and > Arrows	Scroll left to right through the sample details.
^ and v Arrows	Scroll up and down through the sample details.
Transmit	Sends the results.

Reports Tab

Use the Reports tab to generate, view, and print reports.

Table 25. Reports Tab Screen Elements

Report and Type list	Report lists the categories of reports. The selections in the Type list change depending on the selection you made from the Report list.
-----------------------------	--

Generate	Generates the report, The Data Interpretation Report displays, with additional buttons, depending on the size of the report.
	Page - Use the arrows to scroll through the pages being displayed.
	Save - Saves the analyte information currently displayed.
	Print - Prints the analyte information currently being viewed.
	New Report - Returns you to the main Reports window.

Protocols Page

Protocols Tab

Use the Protocols tab to choose an existing protocol.

Figure 26: Protocols Tab

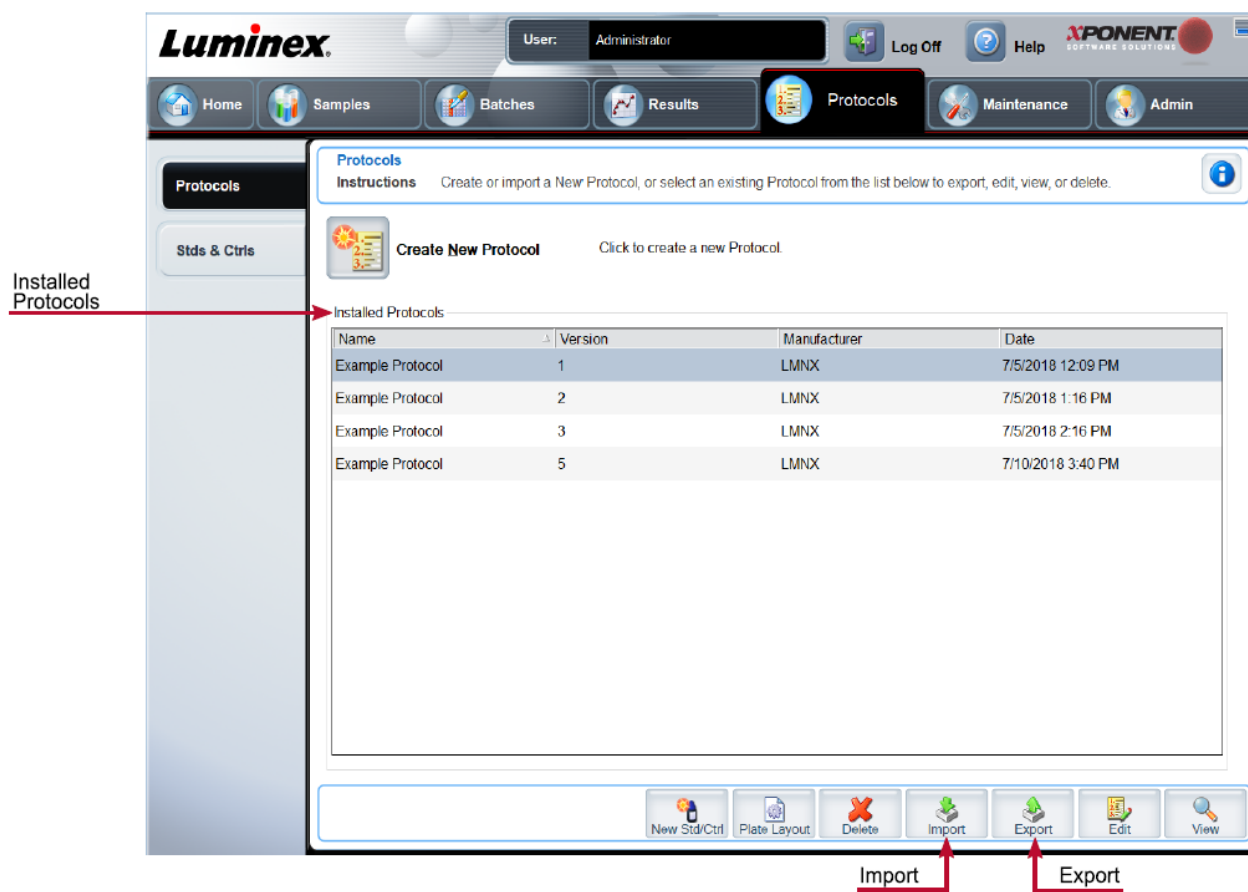

Protocols Tab > Settings Subtab

Figure 27: Settings Subtab

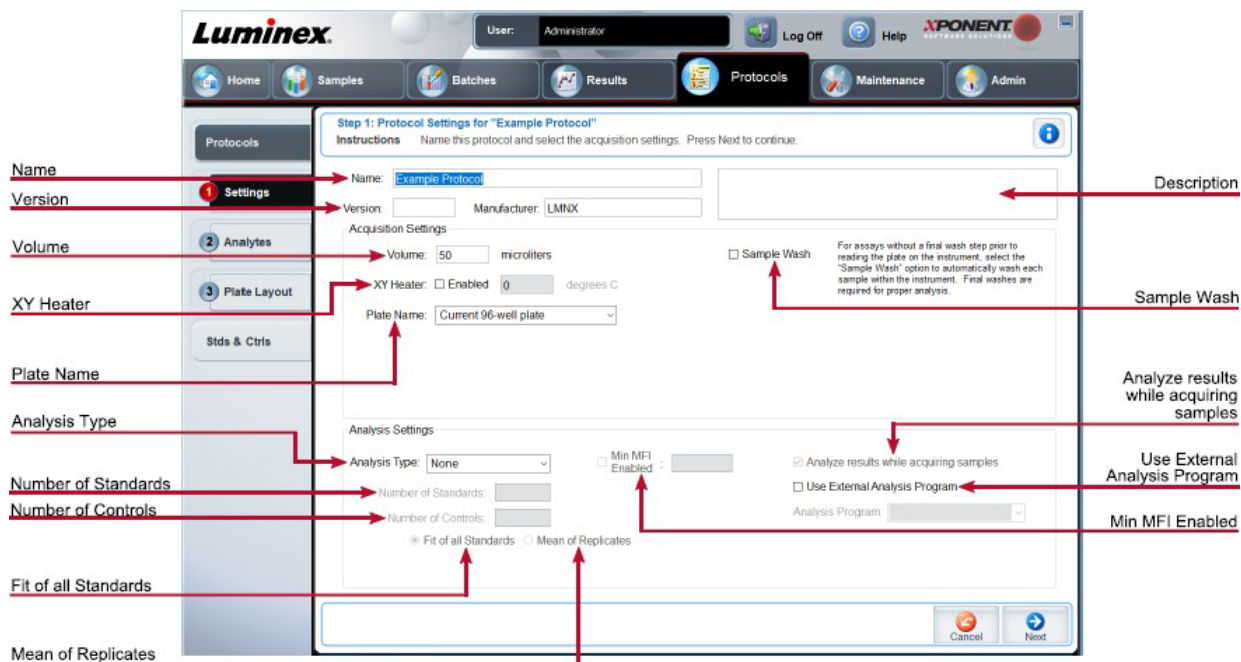

Table 26. Protocols Tab > Settings Subtab Screen Elements

Name and Description fields	The name and description of the protocol.
Version	Version number of the protocol.
Manufacturer	Manufacturer of the protocol.
Volume	The volume the instrument aspirates in to the system for analysis. Enter the desired sample volume in microliters. Use values from 20 µl to 200 µl. To avoid air intake, add at least 25 µl to the sample well in addition to the sample size. The default value is 50 µl.
XY heater	Select Enabled to enable the XY heater. In the field, type the desired value in degrees C . The temperature range is 35°C to 60°C in 0.5°C increments. NOTE: Acquiring data before the heater has reached the proper temperature can compromise test results.
Plate Name	The name assigned to the plate during sample probe height adjustment. Choose the correct plate from the list.
Sample Wash	This option is for assays without a final wash step prior to reading the plate on the instrument. This automatically washes each sample within the instrument. Final washes are required for proper analysis.

Analysis Type	Use this list to choose from the following analysis types:
	None - No analysis. Choose if you have your own data post-processing program and want to obtain only median fluorescent intensity results. You cannot apply standards or controls when you select None . You cannot use xPONENT® to analyze acquisitions with this setting.
	Qualitative - Qualitative analysis determines results as either positive or negative, reactive or non-reactive.
	Quantitative - Quantitative analysis determines the sample concentrations from standard curves using regression methods: Cubic Spline , Linear , Logistic 4P , and Logistic 5P .
Number of Standards	Number of standards for the protocol. Applies only to qualitative and quantitative analyses.
Number of Controls	Number of controls for the protocol. Applies only to qualitative and quantitative analyses.
Fit of all Standards	Use each individual standard replicate when calculating the standard curve. Applies only to quantitative analysis.
Mean of Replicates	Average the individual standard replicates when calculating the standard curve. Applies only to quantitative analysis.
Use External Analysis Program	This option is for those using a program other than xPONENT® to analyze collected data. Applies only to qualitative and quantitative analysis.
Analyze results while acquiring samples	The software allows real-time viewing of the results as the instrument analyzes samples. This feature is not available if you select None as your analysis type.

Protocols Tab > Analytes Subtab

Use the Analytes subtab to select or edit analytes used in the batch or protocol.

Figure 28: Analytes Subtab

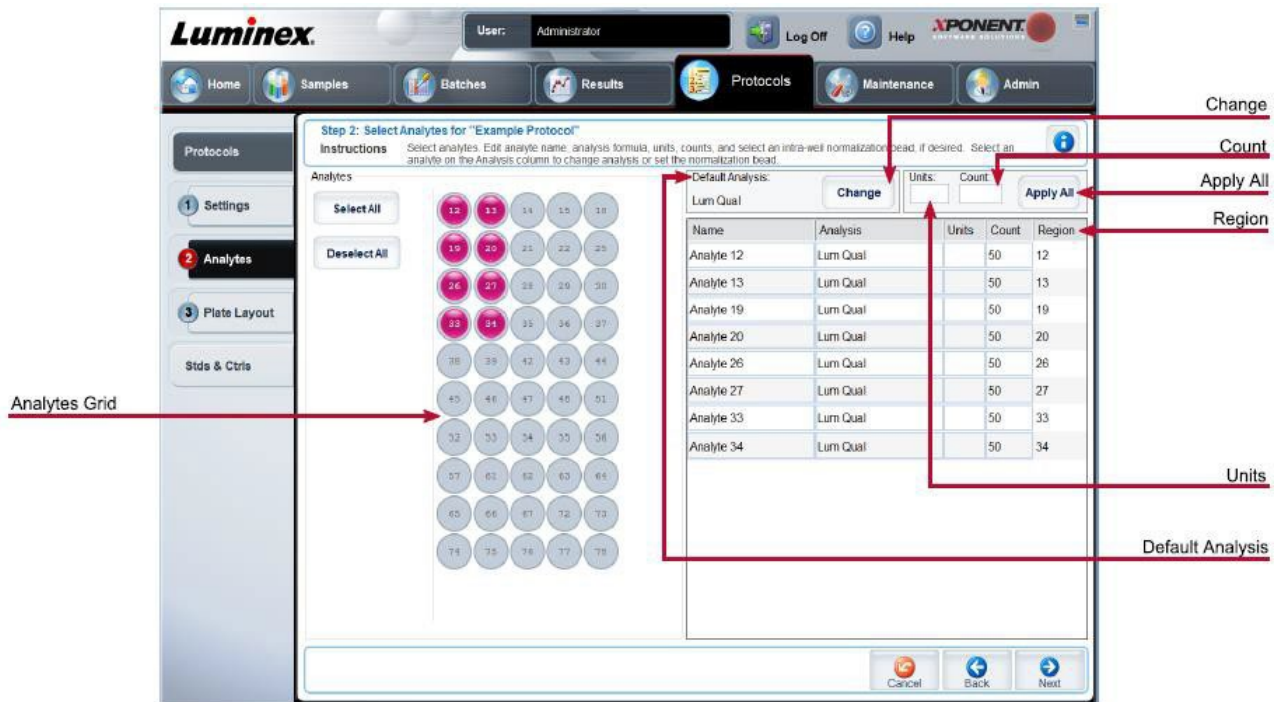

Table 27. Analytes Subtab Screen Elements

Analytes grid	A grid representing each analyte from 12 to 79.
Select All	Selects all analytes.
Deselect All	Deselects all analytes.
Default Analysis	The default analysis changes based on the Analysis Type selected in the Settings subtab. If Qualitative or Quantitative was chosen on the Settings subtab, click Change to change the analysis settings for all analytes.
Count	The desired bead count for the analytes. The instrument will analyze the sample until it has analyzed the count chosen for each bead region or until the timeout is reached if that feature was enabled.
Units	Enter the desired units for the analytes in this field.
Apply All	Applies the information in the Units and Count fields to all analytes.

Selected analytes are displayed in a list on the right side of the Analytes grid. This list includes the following information:	Name - The name of the analyte. Click and type to rename the analyte.
	Analysis - Click this field and choose another analysis from the list, if you want to change it.
	Units - The unit of measurement you specified in the Unit field. Click this field to enter a value for the analyte.
	Count - Enter the desired bead count for the analytes. If each selected bead set does not acquire this number of events, a warning is added to the log that not enough bead events were acquired.
Region - Refers to the specific analyte selected.	

Protocols Tab > Plate Layout Subtab

Figure 29: Plate Layout Subtab

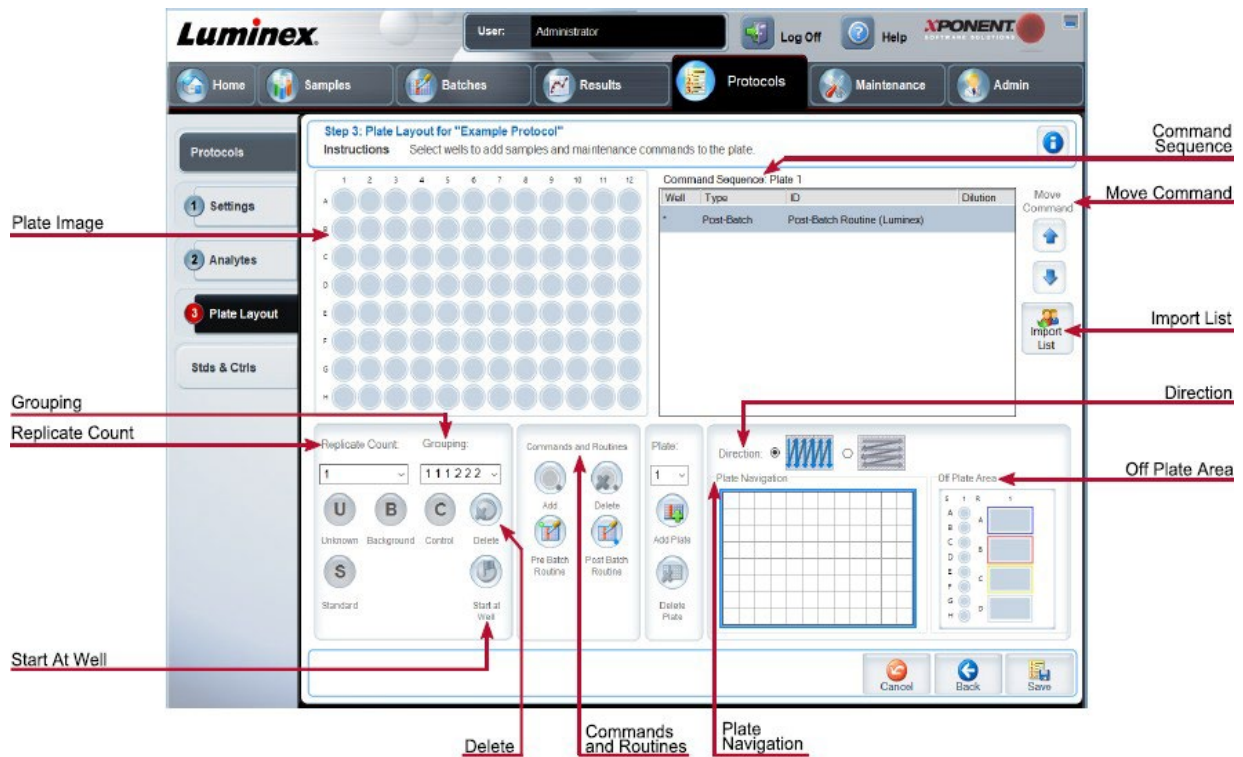

Table 28. Plate Layout Subtab Screen Elements

Plate Image	Represents the plate. Each well appears as a circle on the grid.
Command Sequence	Contains the command sequence for the active plate. A command's ID and Dilution fields have a blue border around them if they can be double-clicked to enter information.

Move Command	Moves a selected well command in the plate up or down in the Command Sequence list, changing the acquisition order.
Import List	Imports an existing command sequence list. NOTE: The import feature allows you to import sample information into unknown wells or wells with specified locations.
Replicate Count	Defines a quantity of replicate sets from one to nine. Replicate count selection must be made before adding a well command.
Grouping	Selects the sequence in which the replicates are laid out in plate wells. Grouping selections must be made before adding a well command. Options for grouping are: 123123123. . . Lays out one of each replicate set at a time in numerical order. 111222333. . . Lays out all the replicates in a set before moving on to the next set in numerical order. Each command is associated with a color. Click and drag to highlight a series of wells, click a column or row header to highlight the entire column or row, or click and highlight different wells and then click a command below to assign that command to all of the highlighted wells.
	Delete - Removes the well command for the selected well.
	Start at Well - Enables you to begin acquisition at a well other than A1.
Commands and Routines	Assigns maintenance commands and routines to a well after you select it in the Command Sequence or plate image area. NOTE: If you select a routine you created, that routine must also exist on any system to which you import this protocol. The system displays an error when attempting to run a batch on a system where the routine does not exist.
	Add - Opens the Commands and Routines dialog box so you can choose a command or routine.
	Delete - Deletes the chosen command or routine.
	Post-Batch Routine - Adds the command or routine before running the batch. Pre-Batch Routine - Adds the command or routine for running the batch.
Plate	Specifies the plate you want to display in the plate image.
	Add Plate - Adds a new plate to the batch.
	Delete Plate - Deletes the plate highlighted in the list.

Direction	Specifies the direction to run the plate commands. Select either horizontally or vertically. The selected direction also dictates how wells are added to the plate when assigning multiple unknowns, standards, and controls at one time
Plate Navigation	Displays a smaller plate image for the current batch. Click and drag in the plate layout to select wells to display. The Plate Navigation section in the lower right part of the window can be used to display all the wells in the plate image. Click and drag in the Plate Navigation dialog box to display different portions of the plate.
Off Plate Area	Designates an alternate location for maintenance commands in the Command Sequence list.
Save Prtcl (When creating a batch)	Opens the Save Protocol dialog box to save the protocol and/or kit. Click Save Protocol and/or Save Std/Ctrl Kit to save the protocol and/or kit. Enter the appropriate information in the fields and click Save to save the protocol or kit.
Run Batch	Runs the batch.

Stds & Ctrls (Standards and Controls) Tab

Use the Stds & Ctrls tab to delete, edit, export, import, and create standards and controls.

Figure 30: Stds & Ctrls Tab

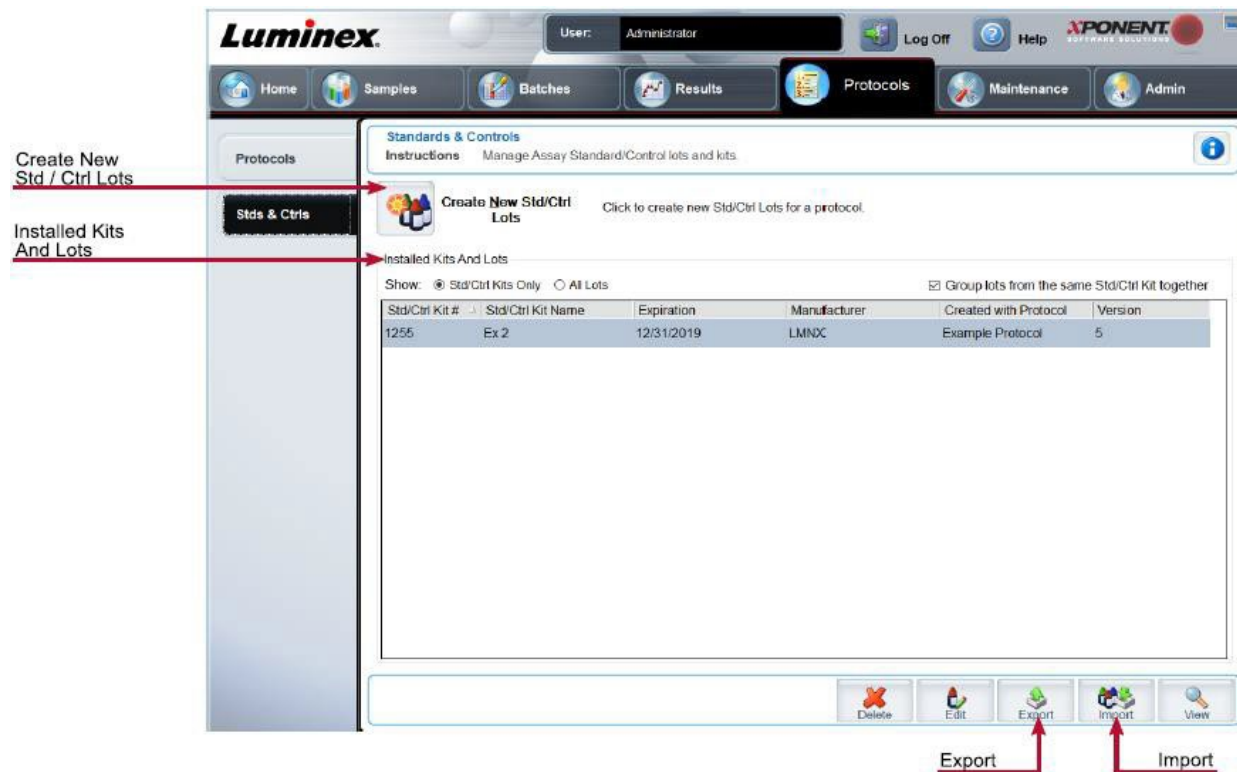

Table 29. Stds & Ctrls Tab Screen Elements

Create New Std/Ctrl Lots	Opens the Select Protocol dialog box. After you choose the protocol, the Std/Ctrl Details subtab displays so you can create a new lot or kit.
Installed Kits and Lots	Displays information about the kits and lots currently installed on the system.
	Show - Click either Std/Ctrl Kits Only or All Lots to choose what to display.
	Select All Lots to display the following information about each installed lot: Reagent, Lot #, Expiration, Name, Manufacturer, Protocol, Versions, Std/Ctrl Kit #, and Std/Ctrl Kit Name.
	Select Std/Ctrl Kits Only to display the following information about the Installed Std/Ctrl Kits : Std/Ctrl Kit #, Std/Ctrl Kit Name, Expiration, Manufacturer, Created with Protocol, and Version.
	Group lots from the same Std/Ctrl Kit together - Groups lots from the same kit together.

Export	Exports the selected lot. Select a location to save the lot file, and click Save .
Import	Select a Std/Ctrl Kit or lot file to import, and click Open .

Protocols Tab > Stds/Ctrls Details (Standards and Controls) Subtab

Use the Std/Ctrl Details subtab to create, edit, or view a kit.

Figure 31: Stds/Ctrls Details Subtab

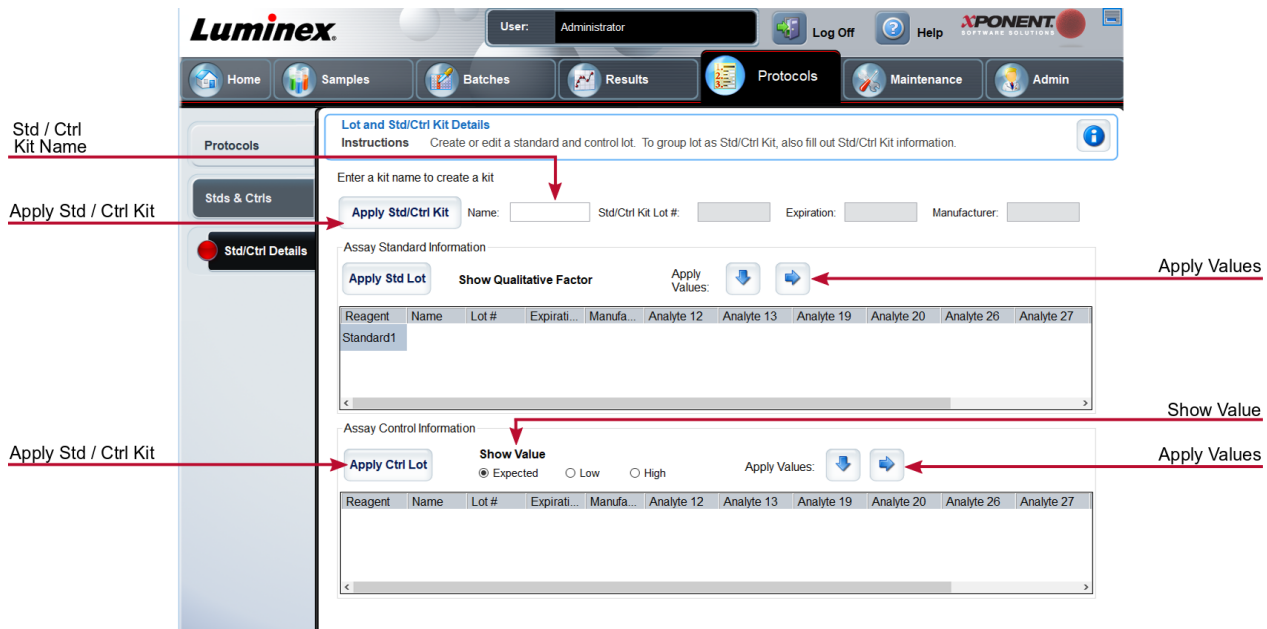

Table 30. Std/Ctrl Details Subtab Screen Elements

Apply Std/Ctrl Kit	Applies a Std/Ctrl kit.
Assay Standard Information	Displays the selected standard reagents in a list.
	Apply Std Lot - Applies the standard lot.
	Apply Values - Applies a value across or down the Reagent, Name, Lot #, Expiration, and Analyte fields. NOTE: The Dilution list and Apply Dilution button only appear if a quantitative analysis has been selected
Assay Control Information	Lists the selected control reagents. Existing control lot information can be applied or new information can be typed manually.
	Apply Ctrl Lot - Applies the control lot.

	<p>Show Value - Expected, Low, and High set the expected, lowest, or highest acceptable concentration of the analyte in the sample.</p>
	<p>Apply Values - Applies a value down or across the list of analytes.</p>
Dilution	<ul style="list-style-type: none"> • Contains the following dilution options: • 1:2 - Halves the standard from each previous iteration. • 1:10 (Log) - Computes a value of one-tenth of the standard from each previous iteration. • 1/2 Log - Creates a 1:3.16 dilution, or half of each 1:10 (Log) from each previous iteration. • As an alternative, you can type a number (must be a whole number) for your own dilution factor.
Apply Dilution	Applies the dilution selected in the Dilution list.
Assay Control Information	Lists the selected control reagents.
	Apply Ctrl Lot - Applies a control lot.
	Show Value - Expected, Low, and High set the expected, lowest, or highest acceptable concentration of the analyte in the sample.
	Apply Values - Applies a value down or across the list of analytes.

Maintenance Page

Use the Maintenance page to maintain and calibrate your system.

Auto Maint (Auto Maintenance) Tab

Use the Auto Maint tab to initialize, verify, and maintain the instrument.

Figure 32: Auto Maint Tab

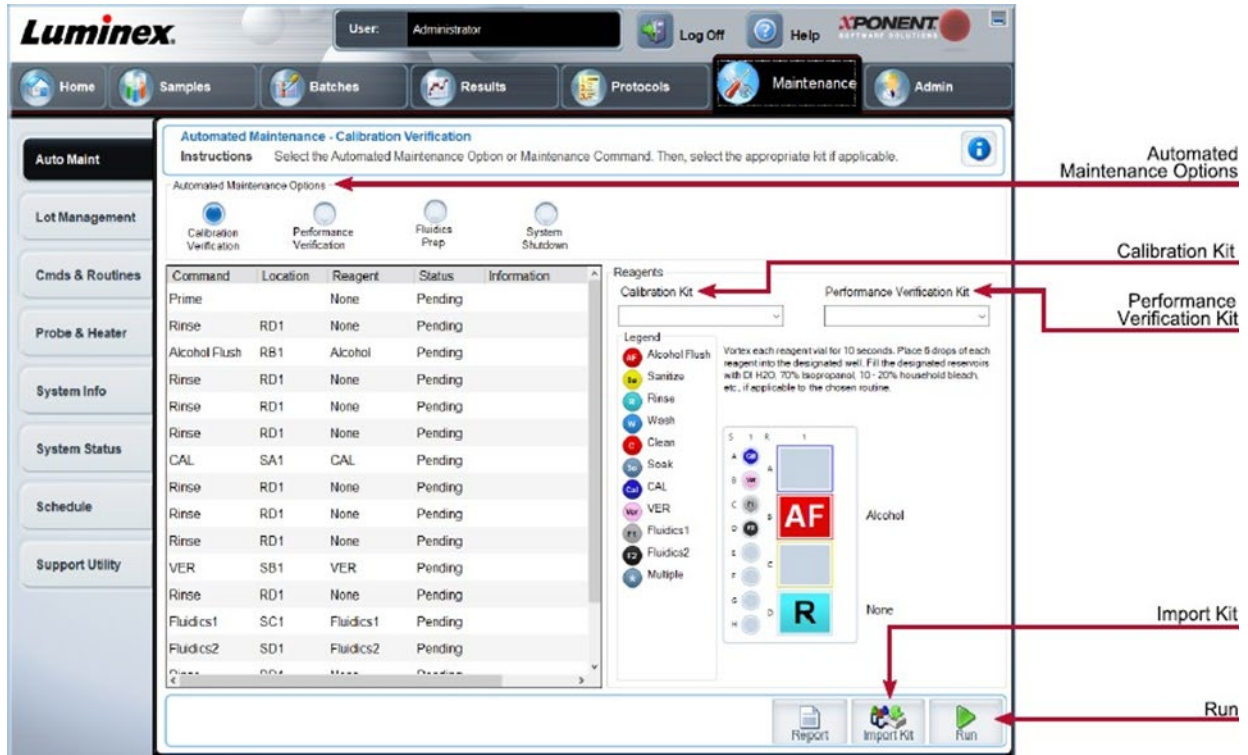

Table 31. Auto Maint Tab Screen Elements

<p>Automated Maintenance Options</p>	<p>Provides buttons for commonly used maintenance routines for the machine.</p> <ul style="list-style-type: none"> • Calibration/Verification • Performance Verification • Fluidics Prep • System Shutdown
<p>Reagents</p>	<ul style="list-style-type: none"> • Calibration Kit • Performance Verification Kit
<p>Report</p>	<p>The Reports tab displays with the Performance Verification Report chosen in the Report: list.</p>

Import Kit	Displays the Calibration and/or Performance Verification kits to choose to import.
Run	Initiates the chosen run.

Lot Management Tab

Use the Lot Management tab to manage calibration and verification kits.

Figure 33: Lot Management Tab

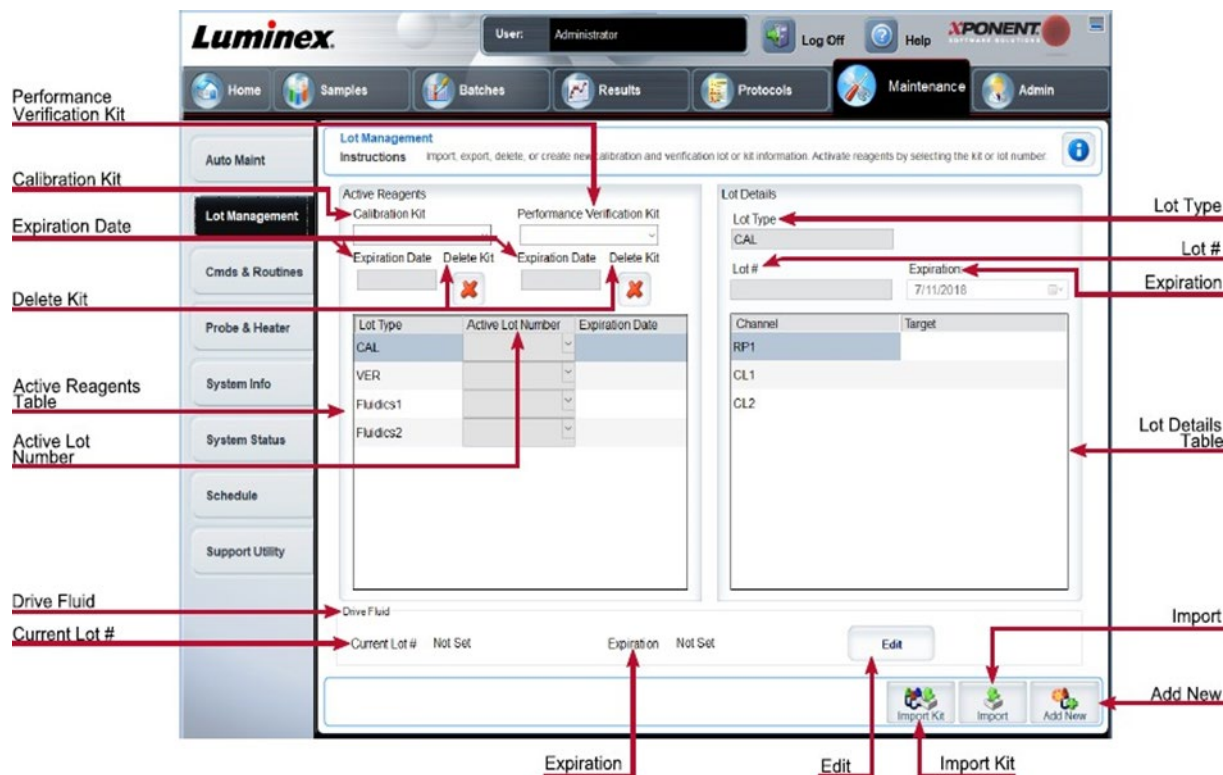

Table 32. Lot Management Tab Screen Elements

	Changes calibration or performance verification kits, lot numbers and expiration dates, or deletes a kit.
Active Reagents	Calibration Kit - Choose a calibration kit from this list.
	Performance Verification Kit - Choose a performance verification kit from this list.
	Delete Kit - Deletes the chosen calibration or performance verification kit(s).
	Active Lot Number - Choose an active lot number for the chosen Kit reagent from this list.

	Active Reagents table - Displays information about the selected reagent. It allows you to choose whether the lot is CAL, VER, Fluidics 1, or Fluidics 2. That choice is displayed in the Lot Details section. The choice changes what columns appear in the table in the Lot Details section.
Lot Details	Displays lot information for the lot chosen in the Active Reagents section.
	Lot Type - Displays the lot type selected.
	Lot # - Enter the lot number after clicking Add New .
	Expiration - Edit the expiration date after clicking Add New .
	Lot Details table - Enter target MFI values for the type of lot you chose in the Active Reagents section. If your choice was CAL, enter targets for CL1, CL2, and RP1. If it was VER, enter targets for each channel for each reagent. If it was Fluidics 1 or 2, you cannot enter any targets.
Drive Fluid	Provides information about the drive fluid.
	Current Lot # - Displays the lot number.
	Expiration - Displays the expiration date.
	Edit - Allows you to add or change the current lot # and expiration.
Import Kit	Opens the Import Calibration or Performance Kit dialog box to import a kit.
Import	Opens the Import Calibrator or Verification Lot dialog box to import a lot.
Export	Opens the Export Calibrator or Verification Lot dialog box. Select a name and location to save the calibrator or verification lot and click Save . You must have a lot chosen in order to Export.
Add New	Adds a new lot. Add information in the Lot Details section on the right side of the window. Enter a Lot # , Expiration , and target in the appropriate boxes and fields. Click Save to save the lot, or click Cancel to cancel the entry.
Delete	Deletes a lot selected in the Active Reagents list.

Commands and Routines (Cmds & Routines) Tab

Use the Cmds & Routines tab to create a routine or to edit, delete, or run a selected routine or command and run one or more maintenance commands with or without saving them as a routine.



MAGPIX® Drive Fluid and the solution in which microspheres are stored contain ProClin®, which may cause an allergic reaction. Use personal protective equipment(PPE), including gloves and safety glasses.

MAGPIX Drive Fluid PLUS contains, and other laboratory reagents can contain, sodium azide as a preservative. Sodium azide may react with lead and copper plumbing to form highly explosive metal azides. Refer to local guidelines and regulations for proper disposal of unused and used MAGPIX Drive Fluid PLUS, as well as other laboratory reagents containing this preservative.

Figure 34: Cmds & Routines Tab

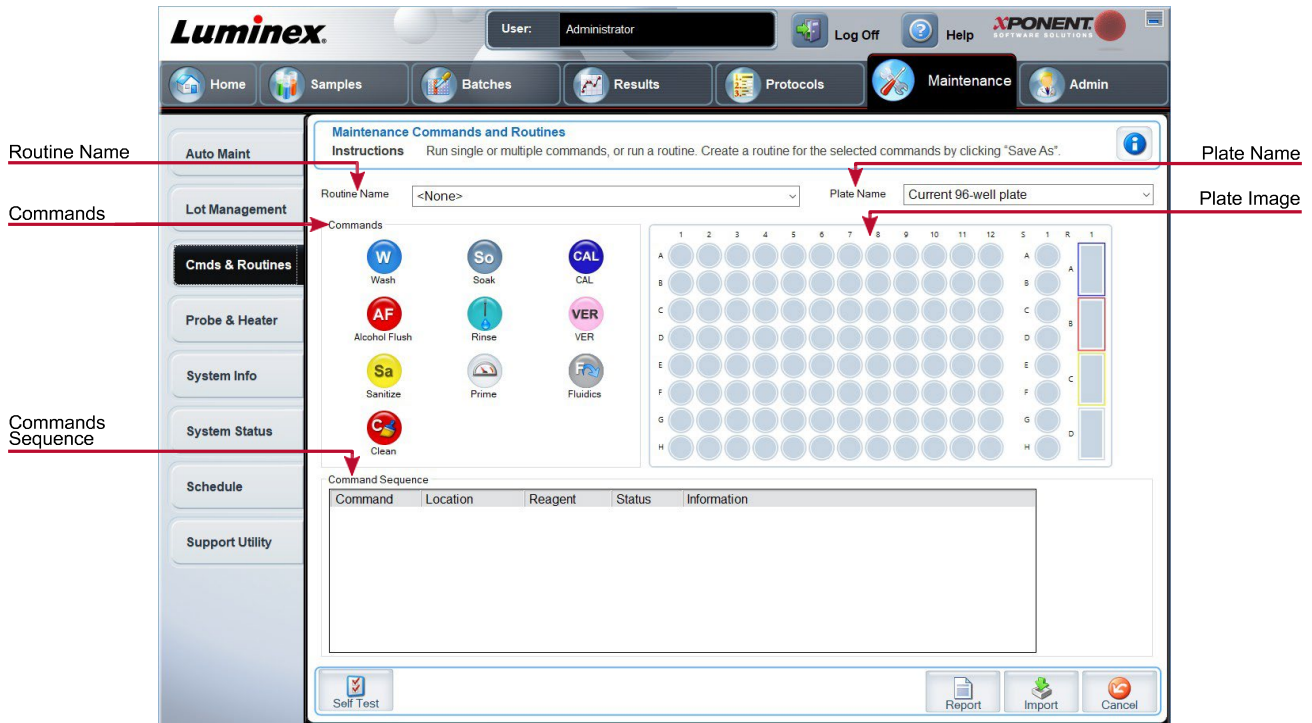

Table 33. Cmds & Routines Tab Screen Elements

<p>Plate Name</p>	<p>The name assigned to the plate during sample probe height adjustment. Choose the correct plate from the list.</p>
	<p>When using multiple plates, use them in the proper order. Failure to do so can result in inaccurate data and test results.</p>

Routine Name	This list of pre-set routines and commands can be used for system maintenance. Some of these commands are also available on the Auto Maint tab. You can also create custom routines which appear in the Routine Name drop-down menu after you save the routine.
Commands	Commands you can add to routines.
	Wash - Sends distilled water through the fluidic lines in the system. It pulls the fluid from a well or from the reservoir and runs it completely through the system to the waste receptacle.
	Alcohol Flush - Removes air bubbles from the sample tubing and the cuvette using 70% isopropanol or 70% ethanol. The alcohol flush takes about 5 minutes.
	Sanitize - Uses the off-plate reagent area, because only the reservoir can accommodate the amount of fluid necessary to sanitize the instrument. The sanitize command performs a similar function as the alcohol flush command, but uses a 0.6% sodium hypochlorite solution with no additives to decontaminate sample lines and the cuvette after biohazard contact. Sanitize as part of your daily shutdown routine after biohazard contact.
	NOTE: Sodium hypochlorite solutions containing small amounts of sodium chloride (NaCl), sodium carbonate (Na ₂ CO ₃), sodium hydroxide (NaOH), and other pH buffers may be used. Do not use sodium hypochlorite solutions containing film-forming agents, such as Diallyldimethylammonium Chloride (DADMAC), or other additives.
	NOTE: The xPONENT® for MAGPIX® software may refer to a 0.6% sodium hypochlorite solution with no additives as '10% to 20% household bleach'.
	Clean - Aspirates a cleaning reagent such as a 0.6% sodium hypochlorite solution with no additives or sodium hydroxide.
	NOTE: Sodium hypochlorite solutions containing small amounts of sodium chloride (NaCl), sodium carbonate (Na ₂ CO ₃), sodium hydroxide (NaOH), and other pH buffers may be used. Do not use sodium hypochlorite solutions containing film-forming agents, such as Diallyldimethylammonium Chloride (DADMAC), or other additives.
	NOTE: The xPONENT® for MAGPIX® software may refer to a 0.6% sodium hypochlorite solution with no additives as '10% to 20% household bleach'.
	Soak - Prevents salt crystals from forming in the probe due to air exposure. Soaking the probe replaces drive fluid in the probe with water. You should perform the soak function at the end of each day. The system uses at least 250 µL of distilled water.
Rinse - Performs a rinse.	
Prime - Removes air bubbles from the system's fluidic pathways by drawing drive fluid from the drive fluid bottle. You do not need to supply solution in a plate.	
CAL - Performs a calibration.	
VER - Performs a verification.	

	Fluidics - Runs fluidics.
Clear	Clears the highlighted command in the Command Sequence list.
Clear All	Clears all commands in the Command Sequence list.
Different buttons appear at the bottom right of the window, depending on your selections in the window.	
Command Sequence	Lists the routines in order in the Command Sequence list. The list includes the name of each command, location, reagent status, and any additional information.
	Self Test - Performs a self-diagnostic to see if the system and all operations are functioning correctly. NOTE: You should perform a Self Test as part of your scheduled weekly maintenance.
	Report - Opens the Reports tab with Calibration and Verification Reports selected in the Report drop-down menu. Click Generate to view the selected report.
	Import - Imports the routine file.
	Cancel - Cancels changes made to the default location of one of the commands in the Command Sequence. Cancel only displays if changes have been made to the command sequence.

Probe and Heater Tab

Use the Probe & Heater tab to adjust the probe height and plate heater settings.

Figure 35: Probe & Heater Tab

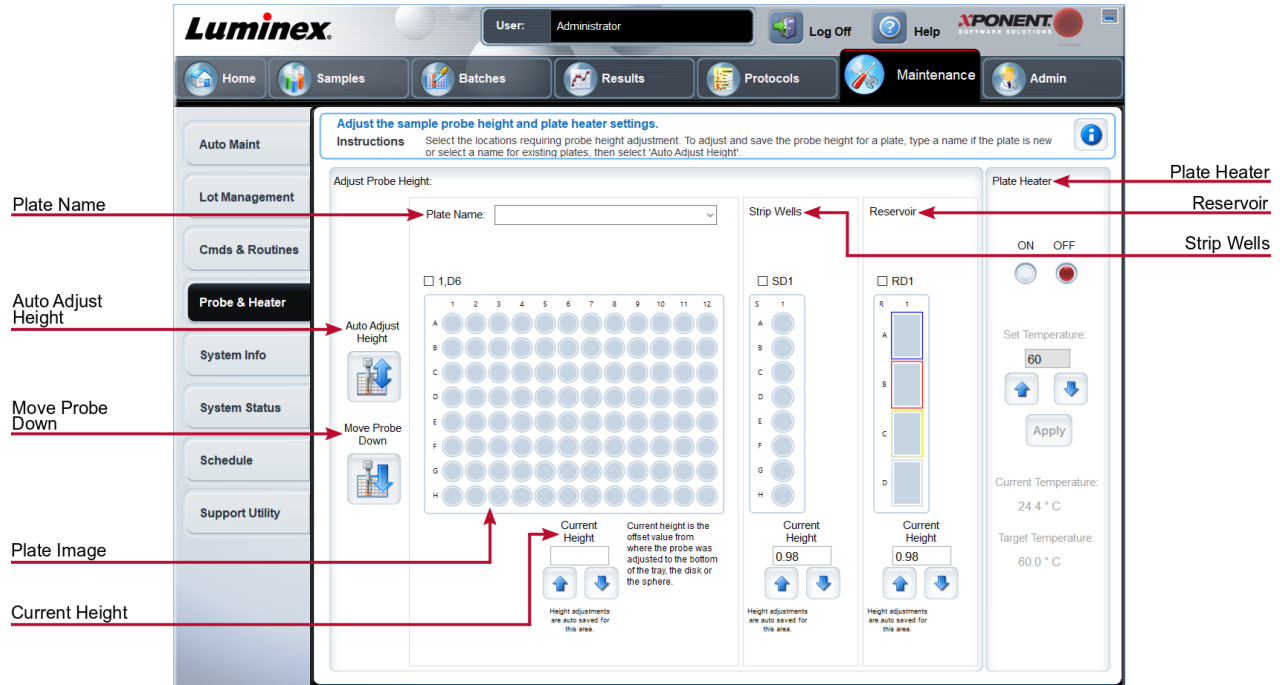



Table 34. Probe & Heater Tab Screen Elements

Plate Name	Enter a name for a plate for future use, or choose an existing plate from the list.
Plate Images	Assigns a particular well to use for probe height adjustment in the main plate, reservoir, and strip wells. Selecting a well displays a green pin to denote its use for the height adjustment.
Current Height	Used to fine tune the probe height after an auto-adjust. Displays the current height of the probe, and the arrows below allow for adjustments up or down.
Auto Adjust Height	Automatically adjusts the probe height using the specified location(s) in the main plate, reservoir, and strip wells. Luminex recommends that you calibrate the probe height using well D6.
Move Probe Down	Moves the probe down in the specified well(s).

Plate Location pin	<p>A green pin that shows the well location used to auto adjust the probe height for the main plate, reservoir, and/or strip wells. The default (and recommended) location for the main plate is well D6.</p> <p>The main plate depicts a 96-well plate.</p> <p>Strip Wells depicts the strip well added to the off-plate reagent area when extra wells are required. A strip well is equivalent to one column of a plate, and, like a plate, its wells can be flat-bottomed, v-bottomed, etc.</p> <p>Reservoir depicts the reservoir added to the off-plate reagent area when procedures require larger amounts of a reagent, such as alcohol or distilled water.</p>
Plate Heater	<p>Enables and disables the Plate Heater by clicking ON or OFF. Also used to set the temperature of the plate to the number typed in the Set Temperature field. Up and down arrows allow half-degree increments. Click Apply to apply the new temperature settings. Current and Target temperatures display at the bottom of this section. The temperature range is 35°C to 60°C.</p>
	<p>The plate heater can become hot enough to cause injury. Use caution when handling after heating.</p>
Save Plate	<p>Appears when you have typed a new plate name in the Plate Name list, and is used to save the current plate. A warning message displays.</p>

NOTE: If you save a plate without performing an auto adjust, the plate name is saved, but the probe height adjustment is not. If you do this, you cannot use the plate with this instrument. If your purpose is to save this plate to use it when you create a protocol to export and, click **Save**. Otherwise, click **Cancel** and perform an auto adjust.

System Info Tab

Use the System Info tab to view information and diagnostics about the Luminex® instrument. This tab contains the following information:

Software	Delta Calibration Temp
Version	System Temperature
Operating System	Last Calibration
Licensing	Last Verification
Instrument Type	Last Fluidics Test
Serial Number	Drive Fluid
Firmware Version	Waste Fluid
Calibration/Verification Status	

Table 35. System Info Tab Screen Elements

Items in the list relating to calibration and verification have one of the following states:

Passed	Indicates that the process completed successfully.
Failed	Indicates that the process was not completed successfully. Failed items appear in red.
Not Current	Indicates that verifiers are not current. Verifiers are not current if you have not calibrated the system since the last time you ran the verifiers.
Not Yet Run	Indicates that this process has not yet been run on the machine.
Copy	Copies the system information to the Windows® clipboard. You can then paste it into a text editor such as Notepad.
Save	Opens the Save As dialog box to specify a file name and location to save the system information file.

System Status Tab

Use the System Status tab to view, print, and save system status log information.

Table 36. System Status Tab Screen Elements

Search by Log Type	Filters the type of log information.
Search by Log Date	Enables using a date range to display a log of system activities.
System Log table	Displays a list of information about each system process.
Export	Enter a name and choose a location for the system log to export to. Select Overwrite to overwrite a pre-existing file. This button exports the file in .CSV format.
Advanced	Displays the following added information in the system log - Log Type, User ID, and Error Level.

Schedule Tab

Use the Schedule tab to view reminders for scheduled maintenance due to be performed on the instrument.

Table 37. Schedule Tab Screen Elements

Reminders	Subject - The scheduled maintenance.
	Reminder - A description of the scheduled maintenance.
	Next Alert Date - The date xPONENT® alerts you about the scheduled maintenance.
	Alert Time - The time xPONENT alerts you about the scheduled maintenance.
	Notes - Any additional information you want to know about the scheduled maintenance.

Support Utility Tab

Use the Support Utility tab to create a support file that you can send to *Luminex Technical Support*. To include batch information in the support file, use the Include Batch Information button and the Select Batch table.

Table 38. Support Utility Tab Screen Elements

Include Batch Information	Select this check box to include batch information with the support file. It activates the Select Batch table.
----------------------------------	---

Select Batch	This table includes columns for the following information about a batch - Name, Protocol, Protocol Version, Date, Status.
Support	Launches the Support Utility dialog box.

Admin Page

You must have the appropriate licenses to view some of the features on the Admin page.

System Setup Tab

Use the System Setup tab to configure system settings such as application settings, Laboratory Information System(LIS) settings, maintenance options, and external analysis program settings. These settings change some of the basic ways that xPONENT® works, allowing customization of many of the basic functions. Select the options you want to enable and click Save.

Table 39. System Setup Tab Screen Elements

Application Settings	Enable Virtual Keyboard - Enables the touch screen virtual keyboard.
	Allow the application to be minimized - Enables minimization of the xPONENT software so that the computer's desktop can be accessed. If this check box is clear, the application's minimize button does not function.
	Ignore user permission when attempting to exit software - Enables the user to exit the xPONENT software, regardless if permission has been granted in the User Setup tab.
	Add header when exporting data from grids - Adds a header row when exporting the data.
LIS Settings	This setting is only for those using xPONENT with a LIS.
	Connect to LIS - Enables connection to the LIS.
	Browse - Opens the Browse For Folder dialog box. Choose a location for the system to watch for incoming orders. This button does not work if LIS is not enabled.
External Analysis Program Settings	This option is for those using a program other than xPONENT to analyze collected data.
	Installed Analysis Programs - Lists the analysis programs currently installed.

	<p>Add New - Opens the New External Analysis Program dialog box.</p>
	<p>Browse - Opens another dialog box to select the file location for the third-party analysis program. The selected location appears in the Path window, and the name displays in the Name field.</p>
	<p>Command Line Parameters - To keep the default command line settings, leave Command Line Parameters blank. Otherwise, type the command line parameter for which parameters you want xPONENT to use with the external analysis program. If the information is supplied with the external analysis program documentation, use that information. Otherwise, you can type the following parameters built into xPONENT, in any order:</p> <p>#c - Output.csv, full file path, #p - Protocol name, #b - Batch name, #u - Logged in user name</p>
	<p>Set Default - Sets the chosen analysis program as the default analysis program for xPONENT.</p>
Remove	Removes the selected program from the Installed Analysis Programs list.
Edit	Opens the New External Analysis Program dialog box where you can edit the settings for the selected program.
Disable Automatic launching of External Analysis when batches complete for all protocols	Disables the automatic launch of the third-party analysis program after batch acquisition.
Arrange Main Navigation Pages	These options enable you to customize the order in which the Main Navigation buttons (pages) display.
	Main Navigation Arrows - Moves the selected header's order of appearance at the top of the window.
	Default - Restores the software to the default page header arrangement.
Maintenance Options	System Initialization Procedure - Displays the available selections to use as the default system initialization procedure.
	Calibration expiration days - Choose the number of days in which the calibration of the system will expire.

Add an External Analysis Program

1. If the program is on an external media such as a CD or flash drive, insert the media.
2. Navigate to the **Admin** page > **System Setup** tab.
3. Click **Add New** to open the **New External Analysis Program** dialog box.
4. Enter a name for the external analysis program.
5. Click **Browse** to navigate to the .exe file for that program. Double-click the file name.
6. Enter the command line parameter for the parameters you want xPONENT® to use with the external analysis program. If the information is supplied with the external analysis program documentation, use that information. Otherwise, you can type the following parameters built into xPONENT, in any order:
 - #c - Output.csv, full file path
 - #p - Protocol name
 - #b - Batch name
 - #u - Logged in user name

NOTE: To keep the default command line settings, leave Command Line Parameters blank.

Edit an Analysis Program

1. Navigate to the **Admin** page > **System Setup** tab.
2. In the **Installed Analysis Programs** list, click the program you want to edit.
3. Click **Edit**. The **Edit External Analysis Program** dialog box displays.
4. Edit the **Name**, **Path**, or **Command Line Parameters**, or make this the default analysis program if there are two or more programs installed. The default analysis program name displays in bold text.

Remove an Analysis Program

1. Navigate to the **Admin** page > **System Setup** tab.
2. In the **Installed Analysis Programs** list, select the program you want to uninstall.
3. Click **Remove**.
4. To prevent the external analysis program from starting automatically, select **Disable automatic launching of External Analysis** when batches complete for all protocols.

Group Setup Tab

This tab is accessible only in the Security or 21 CFR Part 11 packages. Use this tab to assign permissions to different groups of users. Additionally, if you have the 21 CFR Part 11 package, you can require an electronic signature in order to perform selected tasks.

NOTE: The 21 CFR Part 11 package also provides full access to the Secure Package functionality.

Users are assigned to groups and permissions are granted to each group. Do not assign permissions directly to individual users. Use this tab to unlock accounts for users who have locked themselves out of the system.

Table 40. Group Setup Tab Screen Elements

Group Profile	<p>These user groups are predefined:</p> <ul style="list-style-type: none"> • Administrator • Supervisor • Service • Technician2 • Technician1 • Reviewer <p>The user belongs to the group to which you assign them.</p>
Group Features	<p>The Group Features list contains permission categories. When you select a category from the list, the Features section displays the individual tasks that are a part of that category. The following categories are available:</p> <ul style="list-style-type: none"> • System Administration • Batch Management • Protocol Management • Lot and Std/Ctrl Kit management • Import and export data • Archiving
Allowed check box	Enables the selected group to perform that task.
Signature Required check box	Requires a digital signature whenever a user in the selected group performs that task.

Clear **Allowed** and select **Signature Required** to require the electronic signature of another user whose account is configured to allow the action. When you do this, the current user cannot complete the action without this electronic signature. Activities performed with “Signature Required” are tracked in the **System Log**.

Permissions Available by Group

- **System Administration**
 - Manage Users (add, edit, or delete users)
 - Manage System Configuration
 - Perform Calibration and Verification
 - Manage Alerts

- Manage scheduled maintenance
- Change batch options and CSV options
- Allow exit software
- Batch run override system
- Create, delete, activate Cal and Ver Lots and Kits
- **Protocol Management**
 - Create Protocol
 - Edit Protocol
 - Delete Protocol
- **Batch Management**
 - Create Batch
 - Edit Batch
 - Delete Batch
 - Run Batch
 - Validate and Invalidate Results
 - Replay Batch/Recalculate Data
 - Approve Batch
 - Reanalyze Results
 - Save Batch after changing results
 - Change Formula
 - View Processed Batch Results
 - Export Processed Batch Results
- **Lot and Std/Ctrl Kit Management**
 - Create Std/Ctrl Kit and Lots
 - Edit Std/Ctrl Kit and Lots
 - Delete Std/Ctrl Kit and Lots
- **Archiving**
 - Backup/Restore
 - Archive
- **Import and Export Data**
 - Export Batch, Protocol, Kit or Lot Files
 - Import Batch, Protocol, Kit or Lot Files

When you perform an action that requires an electronic signature, the Electronic Signature dialog box displays. The user ID auto-populates. Enter your password and any comments. Click OK to complete the electronic signature, or Cancel to cancel the signature.

Set Up Group Permissions

1. Navigate to the **Admin** page > **Group Setup** tab.
2. In the **Group Profile** drop-down menu, click the group profile you want to set up.
3. In the **Group Features** drop-down menu, choose each group feature you want to set for the group profile you chose.
4. In the **Features** section, select the **Allowed** check box next to the desired permission to enable the selected group to perform that task. If you are using the 21 CFR Part 11 package, enable the **Signature**

Required check box next to the desired permission to require a digital signature whenever a user in the selected group performs that task.

NOTE: These tasks are tracked in the System Log.

NOTE: Depending on the features you choose for the group, the list of permissions change.

5. Click **Save**.
6. In the **Settings Saved** dialog box, click OK.

User Setup Tab

Use the User Setup tab to create or edit a user account, remove a user from the system, or view a list of authorized users and their profile details.

NOTE: You must have administrative privileges and be using the Secure version of xPONENT or the 21 CFR Part 11 version to perform these tasks.

Table 41. User Setup Screen Elements

Create New User	Opens the Create User Account window.
Global User Settings	Password Expiration - Enter a length of time in days. The default is 180 days.
	Unsuccessful Login Attempts - The default number of allowed unsuccessful logins is three attempts.
	Automatic Logoff (seconds) - How many seconds pass until an automatic logoff. Default is 0.
	Minimum User ID Length - The default minimum User ID length is six characters.
	Minimum Password Length - The default minimum password length is six characters.
Users	Displays a list of all users. The list includes ID , Name , and Group Profile information, and indicates whether or not a user account is locked.
Delete User	Removes a selected user from the list.
Edit User	Opens the Edit User Account screen. This screen has the same options as the Create User Account screen.

Create a New User Account

1. Navigate to the **Admin** page > **User Setup** tab.
2. Click **Create New User**. The **Create User Account** window displays.
 - a. Enter the user ID in the **User ID** field. The user ID is not case-sensitive.

NOTE: You can change the required number characters for a user ID on the User Setup tab. Once you create and delete a user ID, you cannot use that user ID again.

- b. Enter the user's name in the **User** field.
 - c. Select the **Account Status** check box to lock the account, or clear this check box to unlock the account.
 - d. Enter a password for the user **Password** field, then re-enter it in the **Reenter Password** field.
 - i. If you want the user to change the password on first login, select **Change password after next login**. The required length for passwords is set on the **Group Setup** tab.
 - e. In the **Group Profile** drop-down menu, choose the role for the user you are creating.
3. Click **Save** to return to **User Setup**.
 4. Click **Cancel** to return to **User Setup** without saving.

Define Global User Settings

The settings in the **Global User Settings** section affect all users in all user groups. You can retain the default settings or type your own values.

To define Global User Settings, complete the following:

1. Navigate to the **Admin** page > **User Setup** tab.
2. In the **Global User Settings** section, type a length of time (in days) for the **Password Expiration**.
3. Set the number of allowed **Unsuccessful Login Attempts**.
4. Set how many seconds pass before an **Automatic Logoff (seconds)** is initiated.
5. Enter the **Minimum User ID Length**.
6. Enter a **Minimum Password Length**.
7. Click **Save**.
8. In the **Settings Saved** dialog box, click **OK**.

Edit User Permissions

1. Navigate to the **Admin** page > **User Setup** tab.
2. In the **Users** section, choose the **user ID**, then click **Edit User**.
3. In the **Edit User Account** window, edit the desired information.
4. Click **Save**.

Restore Account Status

If users attempt to log in unsuccessfully more than the number of times allowed, they will be locked out.

1. Navigate to the **Admin** page > **User Setup** tab.
2. In the **Users** section, choose the **user ID**, and click **Edit User**.
3. Clear the Account status: **Locked** check box.
4. Click **Save**.

Batch Options Tab

Use the Batch Options tab to set options for analysis and acquisition of batches.

Table 42. Batch Options Tab Screen Elements

Batch Options	Allow running a batch if the instrument is not calibrated or verified. - Allows batches to run if the instrument is not calibrated.
	Settings to enable running/saving with expired agents, running with XY temperature out of range, and running a batch if the instrument is not calibrated or verified are managed at the system level. If one or more of these options is enabled, you cannot run batches while the condition exists. However, if you have the group permission Batch run override system, you can run a batch with the condition present. Without Batch run override system you are unable to override any or all of these conditions and therefore cannot run or save batches.
	Use weighting as default option for quantitative analysis. - Sets the weighting for quantitative analysis to default to ON for new protocols.
	Warn when saving/running a New Batch with New Protocol without saving the Protocol and/or Standard and Control information. - Opens a dialog box warning when saving or running a new batch with a new protocol when you have not saved the protocol and/or standard and control information.
Batch Settings	Analysis display decimal places - Enter the number of digits the system displays. The default number of digits is three.
	Calibration expiration days - Enter the desired number of days a system calibration remains active before expiring. The default number is seven.
	Minimum bead count for obtaining results - Enter any whole number from 0 to 1000000. This is the minimum bead count that must be observed by the instrument for a particular analyte before this data is used in statistical calculations and is displayed on the graphs and results table. When set to a number greater than 0, the instrument does not display data for bead sets not generating events equal to or less than this value. Enter 0 to display all events. The default setting is 1.
	Allow batches to be run or saved without lot number, expiration or manufacturer - Allows saving lots without normal required information.
	Default Pre-Batch Routine - System maintenance routines like wash, flush, or clean can be programmed at different points in a batch to prevent clog formation and maintain peak system performance. Pre-batch routines, specifically, are recommended for challenging sample matrices like viscous material or material containing particulates in suspension because these matrices can clog the instrument. Choose the Pre Batch Routine to specify a particular routine to run before running a batch. NOTE: A Rinse command runs after all pre-batch routines.

	<p>Default Post-Batch Routine - A Luminex Post-Batch routine automatically runs at the end of each batch to clean the sample chamber and maintain peak system performance. This cannot be deleted or modified and runs by default. However, you can turn off this routine or use a different routine. Luminex recommends cleaning the system with sodium hydroxide (0.1N NaOH).</p>
	<p>Default Routines - System maintenance routines like wash, flush, or clean can be programmed at different points in a batch to prevent clog formation and maintain peak system performance. Pre-batch routines, specifically, are recommended for challenging sample matrices like viscous material or material containing particulates in suspension because these matrices can clog the instrument. Select this option to specify a particular routine to run before running a batch.</p>
	<p>Default Analysis Graph Axes - Either Log X Axis or Log Y Axis.</p>
Batch Thresholds	<p>Detection enabled - Select or clear for low bead count detection.</p>
	<p>Well Count - When this many consecutive wells acquire a bead count lower than the number specified in the Total Bead Count field, the low bead count action is taken.</p>
	<p>Total Bead Count - The number of beads that must be counted per well to not receive a warning message.</p>
	<p>Action - Select either Error (Stop), Warning (Pause), Warning (Log), or Run Routine. The selected action is taken when the number of wells in the Well Count field are run without reaching the number of beads in the Bead Count field.</p>

Alert Options Tab

Use the Alert Options tab to set options for alerts about various system events.

Set Up Notification Options

To set notification options for various events:

1. Navigate to the **Admin** page > **Alert Options** tab.
2. Select **Dialog** if you want a dialog box to open for a specific event.
3. Select **Email** if you want to send an email notification for a specific event.
NOTE: Make sure the PC is connected to a network before trying to send an email.
4. Select **Sound** if you want a sound to play for a specific event.
5. If you choose to send an email notification for a specific event, and the email address is not already set up, click **Setup Email** to open the **Setup Email** dialog box. Turn email notifications on or off by selecting or clearing the **Email Active** check box.
 - a. Contact your system administrator to determine the correct information for the **Mail Server Host**, **From Email Address**, **From Email Password**, and **Mail Server Port** fields, and if you need to select the **Enable SSL** (Secure Sockets Layer) check box.
 - b. Enter email addresses in the **Email Addresses (separated by commas)** field that you want to send

- alert notifications to.
- c. Click **Test** to send a test email to the addresses you have entered.
6. Click **OK** to apply any changes.
 7. In the **Save Settings** dialog box, click **OK**.

CSV Options Tab

NOTE: You must have administrative privileges to perform this task if you are using the 21 CFR Part 11 or Secure package.

Use the CSV Options tab to define what the CSV (comma-separated values) file will contain and where it will be stored.

Table 43. CSV Options Tab Screen Elements

Automatically export results CSV file when batch is complete	Automatically exports the results to a CSV file when the system finishes analyzing the batch. This allows running programs on exported data without having to manually start the export.
Automatically export batch when batch is complete	Exports batch information automatically when a batch has completed.
Maximum number of data columns in CSV file	Sets the number of individual values in each line of the comma-separated value output file. Each value is separated from the previous and following value by a comma.
Use US regionalization format only	Exports data only in US regionalization format. Use this option if your external analysis program requires a CSV output file with US delimiters.
Include Advanced Statistics	Exports advanced and additional statistics, for example, trimmed counts, in the CSV file. See the CSV file specification for details.
CSV Export Folder and Automatically Exported Batch Folder	Displays the path and location where the CSV file or automatically exported batch file will be exported. Click Browse to change the file export location.
Automatically Export LXB files	Displays the path and location where the LXB file will be exported. Click Browse to change the file export location.
Automatically Export Run CSV files	Displays the path and location where the Run CSV file will be exported. Click Browse to change the file export location.
Automatically convert the raw run files to CSV format for each well in the batch	Automatically converts raw run files to CSV format for each well in the batch. This option creates a CSV formatted file for the raw bead data of each well.
Test Sort Order	Defines a method to sort the test data. The options are By Analyte Name , By Region ID , or By Setup Order .

Archive Tab

Use the Archive tab to archive all file types - batches, protocols, kits, lots, and Laboratory Information System (LIS) records.

When you click the Launch Archive Utility button, the Archive Utility dialog box displays.

NOTE: To back up or restore xPONENT® files, quit the application and select xPONENT ARCHIVE from the Windows® Start menu.

Archive Utility Dialog Box

Click the Launch Archive Utility button to open the Archive Utility dialog box.

The Archive Utility can be used within xPONENT® to set up the frequency and types of files to back up. Statistics about disk space and archive space used, as well as the types of files to back up, appear on this page.

The archive utility runs continuously. If automatic archives are scheduled, they occur whether xPONENT is running or not. When you want to backup or restore xPONENT, quit the application and run the Archive Utility from the Start menu.

Schedule Overview	Schedules archiving.
First Occurrence	Select the date and time for the first automatic archive.
Frequency	Establishes how frequently the system performs the archive process.
Reminder Only	Establishes whether you want a regular reminder from the system so that you can perform archiving manually.
To Be Archived	Establishes which files are archived.
Archive Folder	Select the folder in which files are archived. If the output folder is on a network share and the share becomes unavailable, the system archives locally and sends you a note where the archived files are.
Archive Events	Lists all events related to archiving activity.
System	Displays how many files of each type are currently in xPONENT.
System Backup	Backs up your system. It requires a log on and then instructs you to shutdown the xPONENT software and launch the Archive Utility from the Start menu.
System Restore	Restores your system. It requires a log on and then refers you to the Start menu to restore your system.
Manual Archive	Performs a manual archive process. It requires a log on and then opens the Manual Archive window.

Licensing Tab

Contact *Luminex Technical Support* to obtain a license key for xPONENT® for MAGPIX® software.

NOTE: You must restart the computer for the new license to take effect.

Add a New License Key

1. Navigate to the **Admin** page > **Licensing** tab.
2. Click **License** (bottom right corner of window).
3. Copy and paste the new key into the **Your new License Code** field. The **License File** field remains blank.
4. Click **OK**. This closes xPONENT®, applies the license, and restarts xPONENT.
5. Contact *Luminex Technical Support* if you have any difficulty saving or adding a new license key.

Schedule Tab

Use the Schedule tab to view reminders for scheduled maintenance due to be performed on the instrument.

Table 44. Schedule Tab Screen Elements

Reminders	Subject - The scheduled maintenance.
	Reminder - A description of the scheduled maintenance.
	Next Alert Date - The date xPONENT® alerts you about the scheduled maintenance.
	Alert Time - The time xPONENT alerts you about the scheduled maintenance.
	Notes - Any additional information you want to know about the scheduled maintenance.

Edit Maintenance Schedule Settings

1. Navigate to the **Admin** page > **Schedule** tab.
NOTE: The Schedule tab can also be accessed from the Maintenance page, but the settings cannot be edited from there.
2. On the **Schedule** tab, use the drop-down menus to edit the **Alert Time** and **Recurrence** frequency for any scheduled activity.
3. Enable or disable the reminders by selecting or clearing the **Enabled** check box.
4. Click **Save**.
5. In the **Settings Saved** dialog box, click **OK**.

Report Options Tab

Use the Report Options tab to set how reports are displayed and printed.

Customize How the Report Looks

1. Navigate to the **Admin page > Report Options** tab.
2. Enter a company name in the **Company** field, and any additional information in the **Info** field.
3. Click **Import Logo** to open the **Windows® Open** dialog box and select the file you want to use for the logo at the top of reports. Click **Open**.

NOTE: The logo file should be 920 x 125 pixels. If you want the logo to display to the right of your company name, include 120 pixels of white space to the left of the logo in the graphic file. If you do not include white space, the logo may display behind the company information.

4. Click **Clear Logo** to return to the default logo. (Optional)
5. Click **Save**.
6. In the **Settings Saved** dialog box, click **OK**.

© 2018 - 2023 Luminex Corporation. All rights reserved. No part of this publication may be reproduced, transmitted, transcribed, or translated into any language or computer language, in any form or by any means without prior express, written consent of Luminex Corporation.

Luminex Corporation (Luminex) reserves the right to modify its products and services at any time. Notifications will be sent to end users regarding changes that impact the use, performance and /or safety and effectiveness of the device. Any modifications to the device will be made in accordance with applicable regulatory requirements. Luminex assumes no liability for any damages resulting from the off-label application or misuse of this information.

Luminex, MAGPIX, xPONENT, MagPlex, xTAG, NxTAG, and xMAP are trademarks of Luminex Corporation, registered in the U.S. and other countries.

All other trademarks are trademarks of their respective companies.

This product, or use thereof, is covered, in whole or in part, or made by processes covered by one or more patents: www.luminexcorp.com/patents.

For EU only: Please be aware that any serious incident that has occurred in relation to this IVD medical device should be reported to Luminex Technical Support and the competent authority of the EU Member State in which the user and/or patient is established.